

GTV

Kitchen Accessories

Akcesoria Kuchenne

2025

1 → Systemy szuflad

Drawer systems

Nowoczesne rozwiązania łączące elegancki design z niezawodną funkcjonalnością w Twojej kuchni.

Modern solutions that combine elegant design with reliable functionality in your kitchen.

2 → Prowadnice

Slides

Solidne i niezawodne produkty, które zapewniają płynny wysuw szuflady.

Robust and reliable products that provide smooth drawer opening.

3 → Akcesoria do szuflad

Drawer accessories

Praktyczne dodatki, które pomagają utrzymać porządek i zwiększyć funkcjonalność szuflad kuchennych.

Practical additions to help keep your kitchen drawers tidy and more functional.

4 → Kosze cargo

Cargo baskets

Ergonomiczny system przechowywania do nowoczesnej kuchni.

Ergonomic storage system for the modern kitchen.

5 → Ociekarki

Dish racks

Porządek w kuchni zaczyna się od czystych naczyń.

Tidiness in the kitchen starts with clean dishes.







Na nowoczesną kuchnię składają się dwa najważniejsze elementy: **ergonomia i estetyka.**

Przestrzeń kuchenna musi być zorganizowana tak, aby ułatwić każdemu swobodne poruszanie się w niej i wygodne korzystanie z szafek, szuflad oraz wszelkich akcesoriów. By w pełni wykorzystać potencjał kuchni, warto postawić na funkcjonalne i minimalistyczne rozwiązania.

A modern kitchen consists of two key elements: ergonomics and aesthetics. The kitchen space must be organised to make it easy for everyone to move around freely and to use the cabinets, drawers and all accessories conveniently. To make the most of the kitchen's potential, it is worth opting for functional and minimalist solutions.

Zaplanuj własną funkcjonalną przestrzeń.

Plan your own functional space.

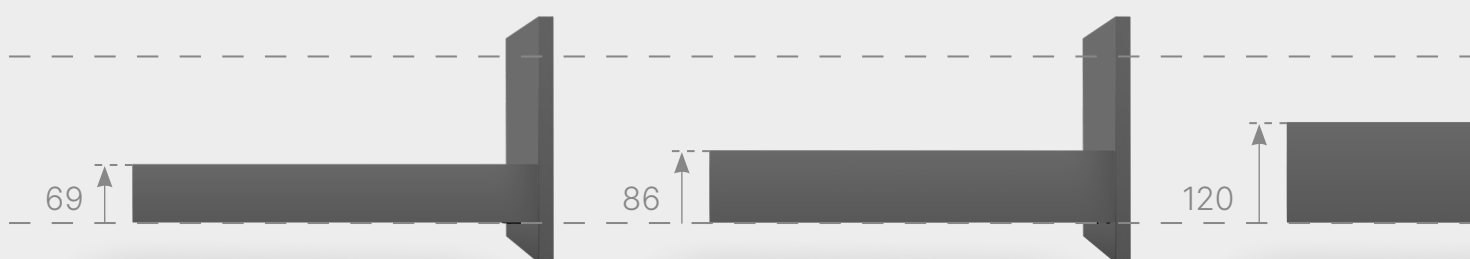

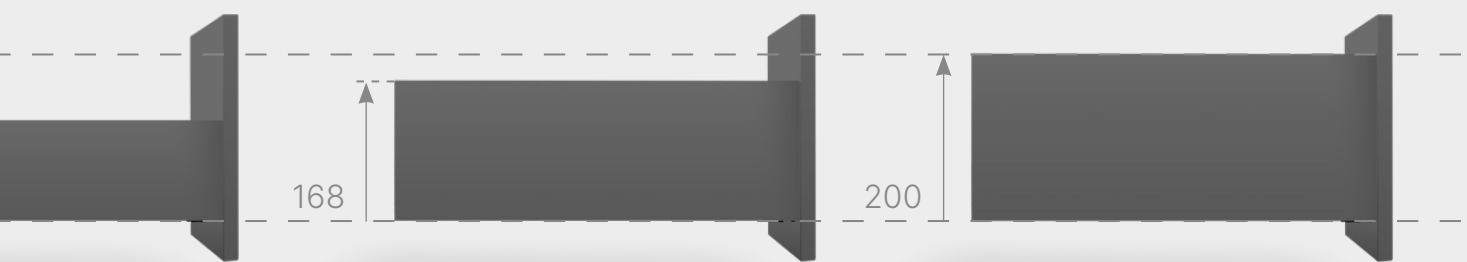

dostępne wysokości (mm)
available heights (mm)

Z systemem szuflad AXIS PRO stworzysz funkcjonalną i estetyczną przestrzeń kuchenną dopasowaną do Twoich potrzeb. Dzięki 5 dostępnym wariantom wysokości, szuflady pozwalają maksymalnie wykorzystać dostępną przestrzeń meblową. Dodatkowo, szeroki wybór akcesoriów pozwala na stworzenie praktycznej szuflady wewnętrznej, zapewniając jeszcze lepszą organizację i wygodę użytkownika.

With the AXIS PRO drawer system, you will create a functional and aesthetically pleasing kitchen space to suit your needs. With 5 available height variants, the drawers make maximum use of the available furniture space.

In addition, a wide range of accessories allows the creation of a practical internal drawer for even better organisation and convenience.

system szuflad

MODERN BOX PRO

drawer system MODERN BOX PRO

MODERN BOX PRO to odpowiedź na rosnące potrzeby klientów co do jakości akcesoriów kuchennych i komfortu ich użytkowania. Sprawdzi się zarówno w małych pomieszczeniach, gdzie liczy się każdy wolny metr, jak i w dużych przestrzeniach, które dają większe możliwości aranżacji. System spełni oczekiwania nawet najbardziej wymagających użytkowników.

MODERN BOX PRO is the answer to the growing needs of customers for quality kitchen accessories and comfort of use. It will work well in small rooms where every free space counts, as well as in large spaces that offer greater design possibilities. The system will meet the expectations of even the most demanding users.

Nowoczesne rozwiązanie dla każdego rodzaju kuchni.

A modern solution for every type of kitchen.

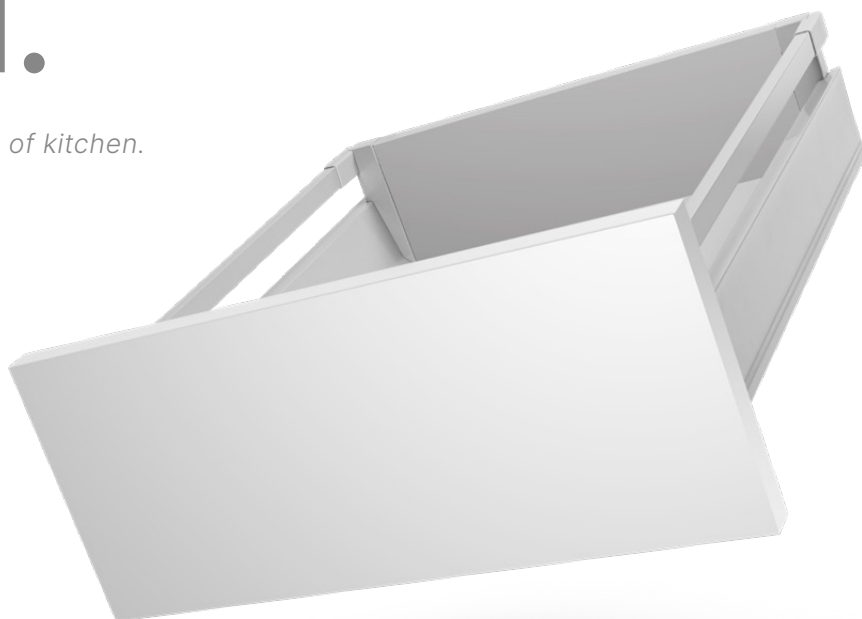



- ⊕ Sprawdzona, certyfikowana trwałość produktu na 60 000 cykli.
Proven, certified product durability of 60,000 cycles.

- ⊕ Pełny wysuw w długościach od 300-550 mm.
Full extension in lengths from 300-550 mm.

- ⊕ 4 warianty wysokości: 84, 135, 167, 199 mm.
4 height variants: 84, 135, 167, 199 mm.

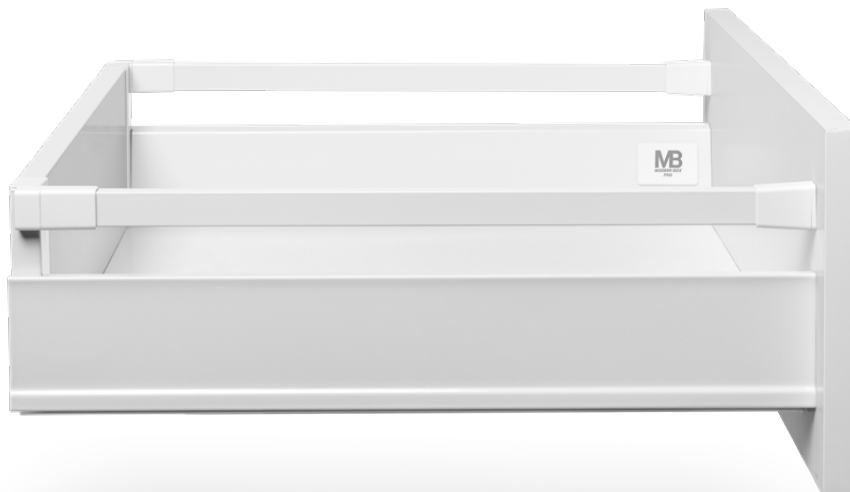

- ⊕ Synchronizacja toru jazdy prowadnic zapewnia płynne przesuwanie nawet przy obciążeniu do 40 kg.
Synchronisation of the path of the guides ensures smooth sliding even with loads of up to 40 kg.

- ⊕ Możliwość zastosowania frontu wewnętrznego, dodatkowych relingów.
Possibility of an internal front, additional railings.

- ⊕ Trzy modne kolory: biały, antracyt, szary.
Three fashionable colours: white, anthracite, grey.





System szuflad MODERN BOX PRO umożliwia maksymalne wykorzystanie przestrzeni i wprowadzenie ładu w każdej zabudowie meblowej. Dzięki zestawowi dedykowanych akcesoriów, system pozwala na tworzenie rozwiązań idealnie dopasowanych do różnych potrzeb. To połączenie trwałości, estetyki i wygody na najwyższym poziomie.

The MODERN BOX PRO drawer system makes maximum use of space and brings order to any furniture arrangement. Thanks to a set of dedicated accessories, the system allows the creation of solutions perfectly adapted to different needs. It combines durability, aesthetics and comfort at the highest level.

Funkcjonalna solidna konstrukcja wyposażona w płynny wysuw i cichy domyk, zapewnia komfort użytkowania na co dzień.

The functional solid construction equipped with a smooth extension and a soft close mechanism ensures everyday comfort.



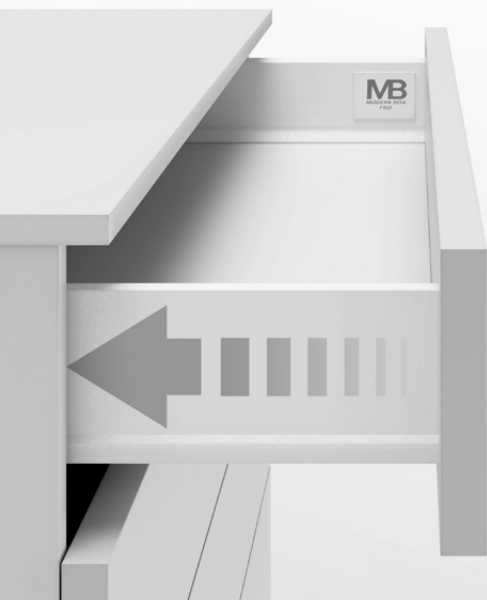

Certyfikat
60.000 cycles
Certificate
60 000 cycles

Cichy domyk

Soft close mechanism

Zastosowanie mechanizmu cichego domyku gwarantuje bezszelestne użytkowanie o każdej porze dnia i nocy.

The soft close system ensures silent operation at any time of the day or night.



Wytrzymałość na obciążenia

Load capacity

System MODERN BOX PRO pozwala na obciążenie szuflady aż do 40 kg, zapewniając bezpieczne przechowywanie ciężkich produktów i akcesoriów kuchennych.

The MODERN BOX PRO system allows a drawer load of up to 40 kg, ensuring safe storage of heavy products and kitchen accessories.

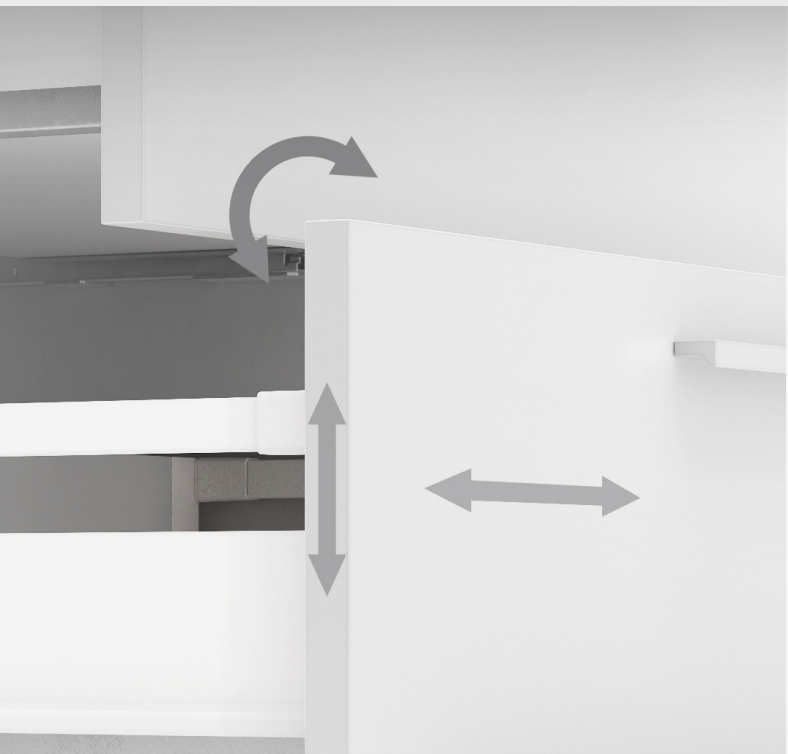

Precyzyjna regulacja w 3 płaszczyznach

Precise adjustment in 3 dimensions

Łatwy montaż dzięki precyzyjnej regulacji od wewnątrz, korekcie pochylenia frontu relingiem szuflady B, C, D oraz regulacji pionowej i poziomej $\pm 1,5$ mm.

Easy assembly thanks to precise adjustment from the inside, front inclination correction with drawer rails B, C, D and vertical and horizontal adjustment of ± 1.5 mm.





System szuflad MODERN BOX PRO to wszechstronne rozwiązanie, które sprawdzi się w każdej kuchennej aranżacji, od kompaktowych wnętrz po przestronne zabudowy. Solidna konstrukcja, nowoczesna estetyka i bogaty wybór akcesoriów sprawiają, że to wybór godny najbardziej wymagających użytkowników.

The MODERN BOX PRO drawer system is a versatile solution for any kitchen design, from compact interiors to spacious built-ins. Robust construction, modern aesthetics and a wide range of accessories make it a choice worthy of the most demanding users.



Prowadnice

Slides

Solidne i niezawodne produkty, które zapewniają płynny wysuw szuflady.

Robust and reliable products that provide smooth drawer opening.



prowadnice

MODERN SLIDE PRO

slides MODERN SLIDE PRO

Cicha precyzja, która podkreśla charakter kuchennego wnętrza.

Quiet precision that enhances the character of the kitchen interior.

Prowadnice dolnego montażu **MODERN SLIDE PRO** to solidne i trwałe rozwiązanie z cichym domykiem, zapewniające płynny ruch i pełny wysuw szuflad. Dzięki regulacji w trzech płaszczyznach i synchronizacji toru jazdy gwarantują precyzyjne dopasowanie oraz komfort codziennego użytkowania.

Prowadnica dolnego montażu **MODERN SLIDE PRO push to open** umożliwia otwieranie szuflad po lekkim naciśnięciu frontu, zapewniając wygodny dostęp bez uchwytów. Pełny wysuw i opcja synchronizacji prowadnic gwarantują komfort oraz płynność działania w każdej kuchni.

Prowadnica dolnego montażu **MODERN SLIDE soft move** łączy wygodę systemu push to open z funkcją soft close, zapewniając ciche domykanie i bezuchwytowe otwieranie. Pełny wysuw i beznarzędziowa regulacja pionowa ułatwiają montaż oraz codzienne użytkowanie.

MODERN SLIDE PRO undermount drawer slides are a robust and durable solution with a soft close for smooth movement and full drawer extension. Thanks to their three-plane adjustment and track synchronisation, they guarantee a precise fit and comfort for everyday use.

The MODERN SLIDE PRO push to open undermount drawer slides allows drawers to be opened when the front is lightly pressed, providing convenient handle-free access. Full extension and the option of synchronised runners guarantee comfort and smooth operation in any kitchen.

The MODERN SLIDE soft move undermount drawer runner combines the convenience of the push to open system with the soft close function, providing quiet closing and handle-free opening. The full extension and tool-free vertical adjustment facilitate installation and daily use.

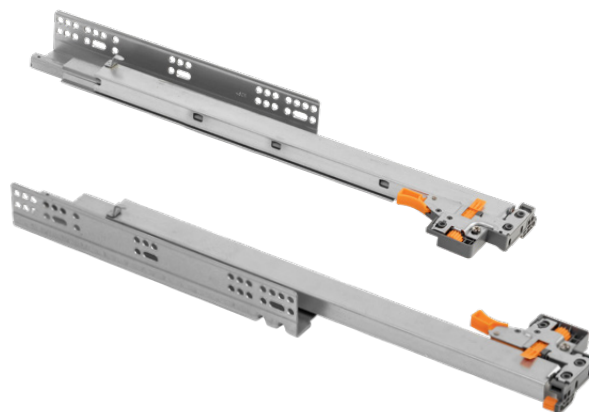

⊕ Informacje techniczne na str. 122
Technical information on page 122



Prowadnice MODERN SLIDE PRO zapewniają pełny wysuw, płynne działanie i wytrzymałość do 35 kg. Dzięki regulacji w trzech płaszczyznach i montażowi nasuwanemu gwarantują łatwe dopasowanie do różnych szuflad.

MODERN SLIDE PRO slides provide full extension, smooth operation and durability of up to 35 kg. Thanks to their three-dimensional adjustment and slide-on assembly, they guarantee easy adaptation to different drawers.



prowadnica **3DOSHX**

slide 3DOSHX

Prowadnica dolnego montażu 3DOSHX z cichym domykiem zapewnia płynne zamykanie, pełny wysuw i wygodną regulację w trzech płaszczyznach bez użycia narzędzi. Ukryte mocowanie do dna szuflady pozwala na zachowanie wysokiej estetyki.

Ponadto trwałość produktu gwarantuje trwałość do 60 000 cykli oraz wytrzymałe obciążenie do 30 kg.

The 3DOSHX bottom-mounted slide with silent closure provides smooth closing, full extension and convenient adjustment in three planes without the use of tools. The concealed attachment to the bottom of the drawer allows a high degree of aesthetics. In addition,

prowadnica **OFPO**

slide OFPO

Prowadnica dolnego montażu OFPO z mechanizmem push to open umożliwia otwieranie szuflady po lekkim naciśnięciu frontu. Pełny wysuw zapewnia wygodny dostęp do całej jej głębokości. Solidna konstrukcja wytrzymuje obciążenie do 25 kg i gwarantuje trwałość do 60 000 cykli.

The OFPO undermount drawer slide with push to open mechanism allows the drawer to be opened when the front is lightly pressed. The full extension provides convenient access to its full depth. The robust design can withstand loads of up to 25 kg and is guaranteed to last for 60,000 cycles.

⊕ Informacje techniczne na str. 123
Technical information on page 123

the durability of the product is guaranteed for up to 60,000 cycles and can withstand loads of up to 30 kg.

⊕ Informacje techniczne na str. 123
Technical information on page 123



prowadnica **GCHX18-H**

slide GCHX18-H

GCHX18-H prowadnica dolnego montażu z cichym domykiem zapewnia płynne i komfortowe zamykanie szuflad w codziennym użytkowaniu. Solidna konstrukcja z regulacją pionową ułatwia montaż, a trwałość do 60 000 cykli oraz obciążenie do 25 kg gwarantują niezawodność użytkowania.

The GCHX18-H undermount drawer slide with silent closure ensures that drawers close smoothly and comfortably in everyday use. The robust design with vertical adjustment makes installation easy, and the durability of up to 60,000 cycles and a load of up to 25 kg guarantee reliable use.

⊕ Informacje techniczne na str. 124
Technical information on page 124

Akcesoria do szuflad

Drawer accessories

Praktyczne dodatki, które pomogą utrzymać porządek i zwiększyć funkcjonalność szuflad kuchennych.

Practical additions to help keep your kitchen drawers tidy and more functional.







wkłady do szuflad **CUSTOMI**

drawer inserts CUSTOMI

Elegancja i porządek w każdej szufladzie.

Elegance and order in every drawer.

Organizery CUSTOMI to eleganckie i praktyczne rozwiązanie do szuflad, które pomoże utrzymać porządek w kuchni.

CUSTOMI organisers are an elegant and practical drawer solution to help keep your kitchen tidy.

Naturalna elegancja w szufladzie.

Natural elegance in a drawer.

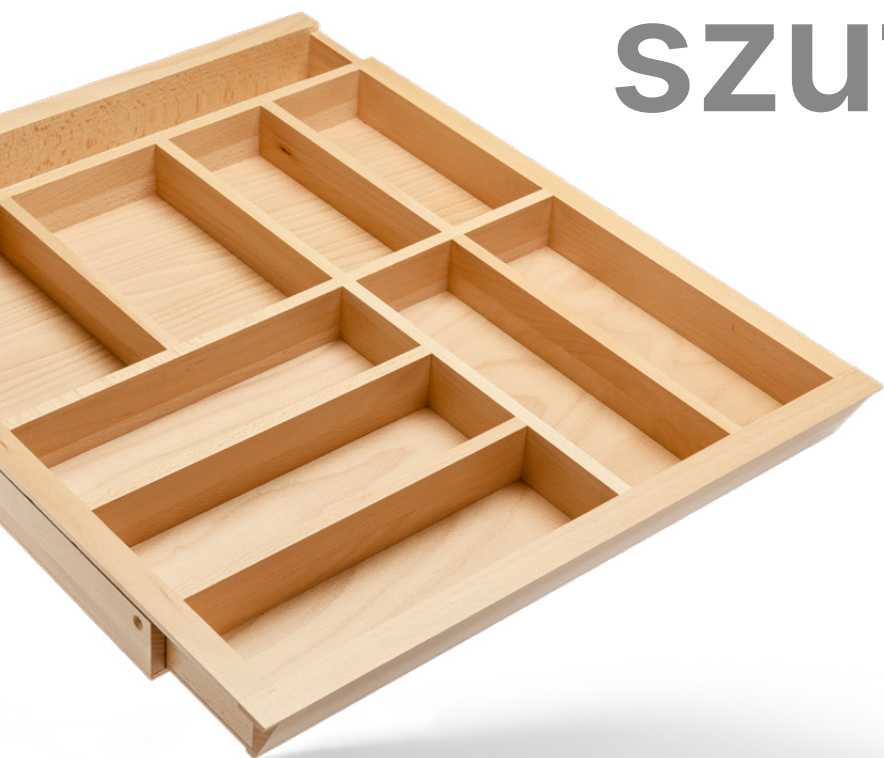

Wykonane są z wysokogatunkowego drewna bukowego, które dzięki swojemu uniwersalnemu charakterowi doskonale komponuje się z każdą zabudową kuchenną.

They are made of high-quality beech wood, which, thanks to its universal character, blends in perfectly with any kitchen design.



Organizery wyróżniają się naturalnym, brązowym wykończeniem oraz starannym wykonaniem z dbałością o każdy detal. Powierzchnię drewna zabezpieczono matowym lakierem, który nie tylko chroni przed uszkodzeniami, ale także podkreśla ciepły, szlachetny odcień buku. Regulowana szerokość od 305 do 535 mm, pozwala na łatwe dopasowanie organizera do wnętrza różnych szuflad, a praktyczne podziałki ułatwiają funkcjonalne rozmieszczenie sztućców i kuchennych akcesoriów.

The organisers are distinguished by their natural brown finish and careful craftsmanship with attention to detail. The surface of the wood has been protected with a matt varnish, which not only protects against damage, but also emphasises the warm, noble shade of the beech. Adjustable in width from 305 to 535 mm, the organiser can be easily adapted to the interior of different drawers and the practical dividers facilitate the functional arrangement of cutlery and kitchen accessories.



wkłady do szuflad **AXISPACE**

drawer inserts AXISPACE

Wszystko w zasięgu ręki.

Everything within easy reach.

Praktyczne, pojemne i eleganckie organizery z wysokiej jakości tworzywa.

Practical, capacious and elegant organisers made of high-quality plastic.



⊕ Informacje techniczne na str. 125
Technical information on page 125

Wkłady do szuflad AXISPACE to praktyczne i pojemne organizery wykonane z wysokiej jakości tworzywa odpornego na zarysowania. Pozwalają efektywnie zagospodarować przestrzeń w szufladzie, utrzymując porządek i sprawiając, że każdy przedmiot ma swoje miejsce. Dzięki specjalnym podziałkom łatwo posegregować łyżki, noże, widelce i inne niezbędne akcesoria kuchenne, mając je zawsze w zasięgu ręki, co jest niezwykle istotne dla każdej osoby zajmującej się gotowaniem. Wkłady dostępne są w sześciu rozmiarach od 340 do 840 mm, a możliwość docięcia krawędzi pozwala precyzyjnie dopasować organizer do wymiarów każdej szuflady.

AXISPACE drawer inserts are practical and capacious organisers made of high-quality scratch-resistant plastic. They allow efficient use of drawer space, keeping things tidy and ensuring that every item has its place. Thanks to special dividers, you can easily sort spoons, knives, forks and other essential kitchen accessories, keeping them always within reach, which is extremely important for anyone who cooks.

The inserts are available in six sizes from 340 to 840 mm, and the option to cut the edges allows the organiser to fit precisely into the dimensions of any drawer.



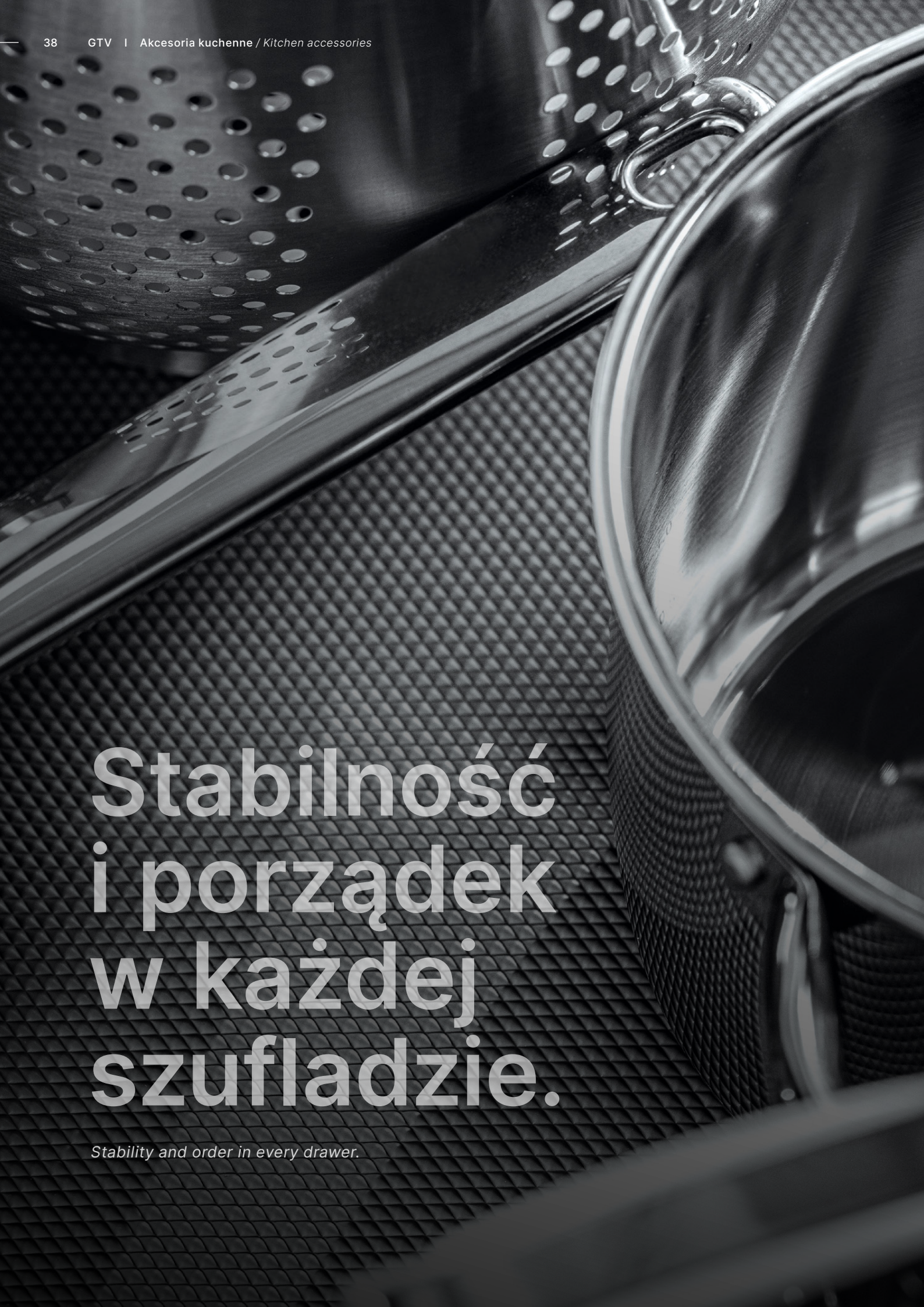

Stabilność i porządek w każdej szufladzie.

Stability and order in every drawer.

maty do szuflad AXISPACE

mats for drawers AXISPACE

Porządek, ochrona, dopasowanie.

Order, protection, fit.

Maty antypoślizgowe AXISPACE to praktyczne rozwiązanie do każdego rodzaju szuflad i szafek.

AXISPACE anti-slip mats are a practical solution for all types of drawers and cabinets.

Możliwość docięcia na dowolny wymiar, ułatwia dopasowanie maty do indywidualnych potrzeb. Wypustki na jej powierzchni skutecznie zapobiegają przesuwaniu się przedmiotów, chroniąc jednocześnie dno szuflady przed zarysowaniami. Maty wykonane są z wysokiej jakości tworzywa, dostępne w trzech ponadczasowych kolorach - białym, czarnym i antracytowym. Dzięki dobremu przyleganiu do powierzchni dna szuflady, zapewniają funkcjonalność i styl w każdej aranżacji.

Can be cut to any size, making it easy to customise the mat. The tabs on its surface effectively prevent items from sliding around, while also protecting the bottom of the drawer from scratches. The mats are made of high-quality plastic and are available in three timeless colours - white, black and anthracite. Thanks to their good adhesion to the surface of the drawer bottom, they provide functionality and style in any arrangement.





segregatory do szuflad **AXISPACE**

waste bins for drawers *AXISPACE*

Innowacyjne rozwiązanie do segregacji odpadów.

An innovative solution for waste separation.

Pojemniki wykonane są z tworzywa zawierającego grafen o właściwościach bakteriobójczych i antygrzybiczych.

The containers are made of graphene-containing plastic with antibacterial and antifungal properties.



Kolory, które ułatwiają segregację.

Colours that make segregation easy.

Dzięki kolorowym uchwytom segregacja jest intuicyjna, a plamoodporna powierzchnia ułatwia utrzymanie czystości.

The coloured handles make segregation intuitive and the stain-resistant surface makes it easy to keep clean.



Informacje techniczne na str. 126
Technical information on page 126



Kosze są kompatybilne z wieloma systemami szuflad i dostępne w zestawach lub jako pojedyncze elementy do indywidualnej aranżacji.

The bins are compatible with a wide range of drawer systems and are available in sets or as individual pieces for individual arrangement.

- Dostępne w dwóch pojemnościach: 7 l oraz 15 l.
- Możliwa aż 8-krotna konfiguracja ustawień.
- Wyprodukowane w Polsce.
- *Available in two capacities: 7 l and 15 l.*
- *Up to 8-fold configuration of settings possible.*
- *Manufactured in Poland.*



segregatory **PRACTI ECO**

bins PRACTI ECO

Czystość bez kompromisów, lepsza przyszłość.

Cleanliness without compromise, a better future..

Pojemniki PRACTI ECO to praktyczne rozwiązanie do wygodnej i efektywnej segregacji odpadów.

PRACTI ECO bins are a practical solution for convenient and efficient waste separation.

Segregacja w nowoczesnym stylu.

Segregation in a modern style.

Segregatory PRACTI ECO zostały wykonane z wysokiej jakości tworzywa z mocowaniem do dna szafki bez mocowania frontu, dzięki czemu doskonale pasują do nowoczesnych kuchni. Prowadnice kulkowe z cichym domykiem zapewniają płynne i delikatne zamykanie, a wysuwany stelaż z koszami gwarantuje wygodny dostęp i dopasowanie do większości szafek kuchennych.

The PRACTI ECO bins are made of high-quality plastic with attachment to the bottom of the cabinet without front attachment, making them a perfect fit for modern kitchens. Ball-bearing guides with silent closure ensure smooth and gentle closing, while the pull-out bin rack guarantees convenient access and fits into most kitchen cabinets.



Informacje techniczne na str. 126
Technical information on page 126



Jednolity antracytowy kolor nadaje im nowoczesny wygląd oraz idealnie wkomponowuje się w każde wnętrze.

The uniform anthracite colour gives them a modern look and blends in perfectly with any interior.

Kosze cargo

Cargo baskets

Ergonomiczny system przechowywania do nowoczesnej kuchni.

Ergonomic storage system for the modern kitchen.





cargo narożne

MOVIX PRO

corner cargo MOVIX PRO

System przechowywania MOVIX PRO to przykład nowoczesnych i uniwersalnych akcesoriów meblowych, dzięki którym zagospodarujemy przestrzenie dolnych szafek kuchennych. Tego typu rozwiązanie to doskonałe miejsce na przechowywanie zapasów żywności, produktów takich jak przyprawy, oleje i oliwy, a także akcesoriów kuchennych.

The MOVIX PRO storage system is an example of modern and versatile furniture accessories with which to utilise the spaces of lower kitchen cabinets. This type of solution is the perfect place to store food supplies, products such as spices, oils and olives, as well as kitchen accessories.



Informacje techniczne na str. 128
Technical information on page 128

KO-WMC450-60



W skład serii MOVIX PRO wchodzi także kosze typu magic corner do przechowywania większej ilości produktów i akcesoriów, które umożliwiają maksymalne zoptymalizowanie trudno dostępnych miejsc w szafkach narożnych.

The MOVIX PRO range also includes magic corner baskets for storing more products and accessories, which allow for maximum optimisation of hard-to-reach spaces in corner cabinets.

cargo boczne

MOVIX PRO

side cargo MOVIX PRO

MOVIX PRO to uniwersalny system do przechowywania akcesoriów kuchennych i sposób na pomysłową i funkcjonalną przestrzeń. Wpływa na jakość pracy w kuchni i podnosi jej ergonomię.

MOVIX PRO is a versatile storage system for kitchen accessories and a solution to create both clever and functional space. It affects the quality of work in the kitchen and improves its ergonomics.

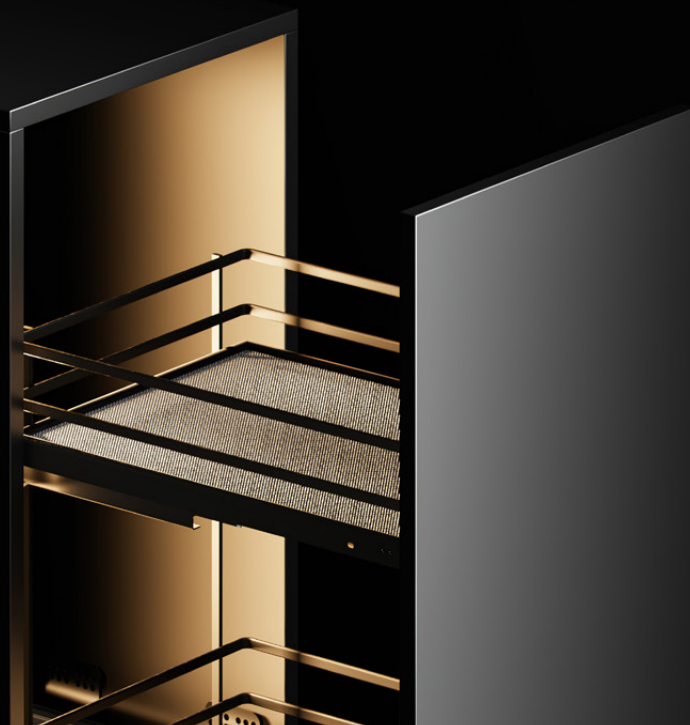

Dedykowane prowadnice dolnego montażu z pełnym wysuwem, cichym domykiem i żywotnością 60 000 cykli gwarantują wysoką kulturę pracy i możliwość jednostronnego montażu – po lewej lub prawej stronie. Cała seria występuje w czterech modnych kolorach: chrom z białą matą, chrom z antracytową matą, pełen antracyt oraz pełna biel.

Dedicated bottom-mounted slides with full extension, silent closing and a service life of 60,000 cycles guarantee high running culture and can be mounted on one side - left or right. The entire series comes in four fashionable colours: chrome with white or anthracite matt, full anthracite and full white.



Kosze cargo umożliwiają przechowywanie produktów w taki sposób, że sięganie po nie jest wygodne i szybkie. Wyposażone w maty antypoślizgowe, estetyczne relingi i wygodną regulację frontu, zapewniają porządek i łatwy dostęp do zapasów.

Cargo baskets allow products to be stored in such a way that reaching for them is convenient and quick. Fitted with non-slip mats, aesthetically pleasing rails and a convenient front adjustment, they keep your stock tidy and easily accessible.





Ociekarki

Dish racks

Porządek w
kuchni zaczyna
się od czystych
naczyni.

Tidiness in the kitchen starts with clean dishes.

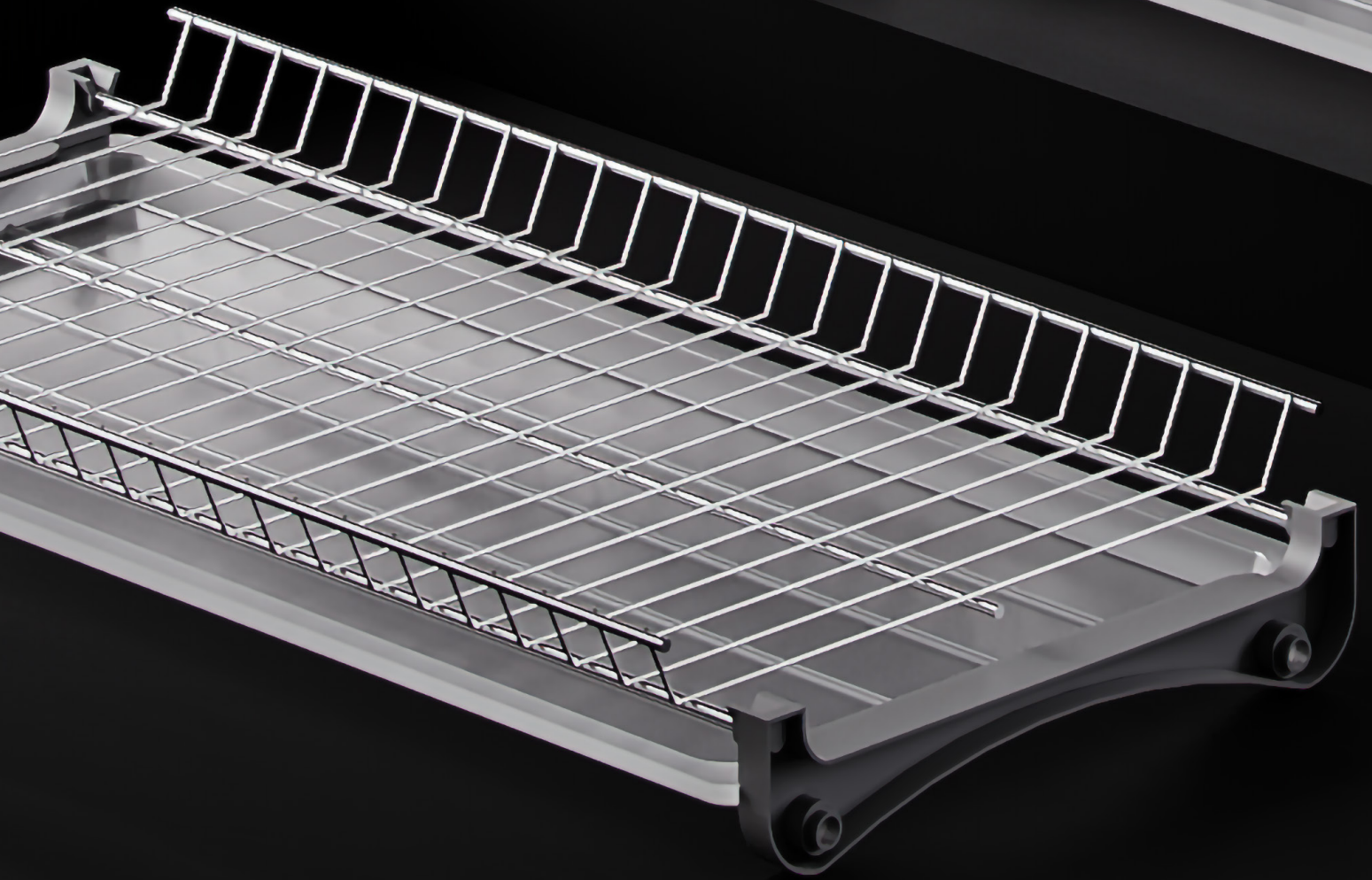
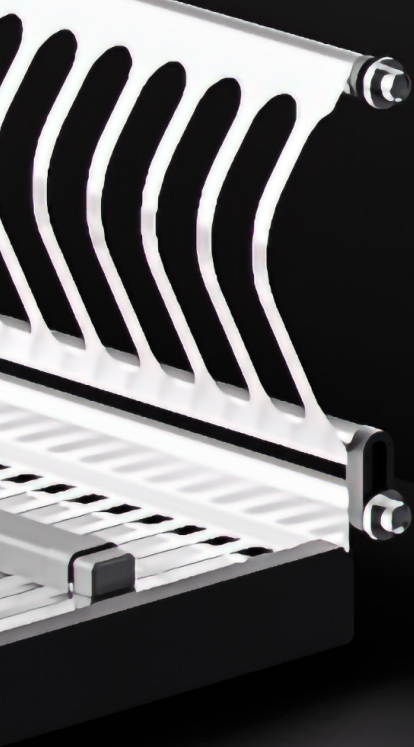

ociekarki BASIC

dish racks BASIC

Ociekarki BASIC dzięki dwupoziomowej konstrukcji zapewniają skuteczne suszenie naczyń oraz zapobiegają gromadzeniu wilgoci w szafkach. Przeznaczone do szafek o szerokościach od 400 do 900 mm wykonanych z płyty o grubości 16 lub 18 mm. Solidne materiały gwarantują stabilność i trwałość, dzięki czemu naczynia pozostają bezpiecznie na swoim miejscu. To niezawodne rozwiązanie, które znacząco usprawni codzienne zmywanie. Dostępne w dwóch ponadczasowych kolorach: chrom i biały.

BASIC dish racks ensure efficient drying of the dishes and prevent the accumulation of moisture in the cabinets thanks to their two-level design. Designed for 400 to 900 mm wide cabinets made of 16 or 18 mm thick board. The robust materials guarantee stability and durability, so that the dishes stay securely in place. It's a reliable solution that will significantly improve everyday washing. Available in two classic colours: chrome and white.

⊕ Informacje techniczne na str. 131
Technical information on page 131



OC-B1400-01



ociekarki OC-A0

dish racks OC-A0

Ociekarki OC-A0 dzięki dwupoziomowej budowie umożliwiają szybkie i wygodne suszenie naczyń bez ryzyka zatrzymywania wilgoci. Przeznaczone do montażu w płytach o grubości od 16 do 19 mm, znacząco poprawią ergonomię i komfort zmywania. Solidna konstrukcja ze szczotkowanej stali nierdzewnej zapewnia nie tylko skuteczne suszenie, ale również estetyczny wygląd na długie lata. W zależności od wybranego rozmiaru, pomieści od 16 do 32 naczyń, łącząc funkcjonalność z nowoczesnym designem.

The OC-A0 dish racks, thanks to their two-level design, allow quick and convenient drying of dishes without the risk of moisture retention. Designed for installation in 16 to 19 mm thick plates, they will significantly improve ergonomics and washing comfort. The sturdy brushed stainless steel construction ensures not only effective drying, but also an aesthetically pleasing appearance for years to come. Depending on the size chosen, it will accommodate between 16 and 32 dishes, combining functionality with modern design.



Informacje techniczne na str. 132
Technical information on page 132

szuflada na naczynia **MOVIX**

dish drawers MOVIX

**Elegancja, porządek i wygoda
ukryta w szufladzie.**

*Elegance, order and convenience
hidden in a drawer.*

Szuflada na naczynia MOVIX to stylowe i funkcjonalne rozwiązanie, które zapewnia porządek i efektywność w suszeniu i przechowywaniu naczyń.

MOVIX dish drawers are a stylish and functional solution for tidiness and efficiency in drying and storing dishes.





Dzięki wytrzymałej konstrukcji, cichym prowadnicom i regulacji frontu w trzech płaszczyznach, szuflady na naczynia idealnie dopasowują się do każdej kuchni, gwarantując wygodę użytkownika.

Thanks to the durable construction, silent runners, and three-dimensional front adjustment, dish drawers perfectly fit any kitchen, ensuring convenient use.

Komfort i efektywność w przechowywaniu naczyń.

Comfort and efficiency in storing dishes.

- Cztery różne rozmiary, do szafek o szerokości od 600 do 900 mm.
- Udźwig do 30 kg gwarantuje bezpieczne przechowywanie naczyń.
- Trwała, odporna na korozję stal.
- Tacka odprowadzająca wodę, zapewnia łatwe utrzymanie czystości.
- Dostępna w dwóch kolorach: chrom, antracyt.
- *Four different sizes, for cabinets from 600 to 900 mm wide.*
- *A load capacity of up to 30 kg guarantees safe storage of dishes.*
- *Durable, corrosion-resistant steel.*
- *Drainage tray for easy maintenance.*
- *Available in two colours: chrome and anthracite.*

Zawiasy

Hinges

Otwórz drzwi
do perfekcji.

Open the door to perfection.





zawiasy

SILENTO PRO

hinges SILENTO PRO

Niezawodność ukryta w detalach.

Reliability hidden in the details.

Zawiasy SILENTO PRO wyróżniają się nie-
zwyczajną wytrzymałością podczas użytko-
wania oraz płynnością mechanizmów przy
ciągłej pracy. Gwarantują ciche otwieranie
i zamykanie frontów meblowych, zapew-
niając komfort na najwyższym poziomie.

*SILENTO PRO hinges are distinguished by
their extraordinary durability during use
and the smoothness of their mechanisms
during continuous operation. They guaran-
tee quiet opening and closing of furniture
fronts, providing comfort at the highest level.*



Gwarancja cichego otwierania i zamykania frontów meblowych.

Guaranteed quiet opening and closing of furniture fronts.

- Regulacja w trzech płaszczyznach.
- Mimośrodowa regulacja głębokości i wysokości.
- Możliwość konfiguracji z różnymi typami prowadników.
- Trwałość certyfikowana na 80 000 cykli.
- Dostępne wersje: do ramek aluminiowych, kątowny 155°, bez sprężyny.
- Dostępne w opcji: nakładanej, bliźniaczej i wpuszczanej.
- Prowadnik typu clip-on.
- Dostępne w dwóch kolorach: nikiel, czarny.
- *Adjustable in three planes.*
- *Eccentric depth and height adjustment.*
- *Possibility of configuration with different types of runners*
- *Durability certified at 80,000 cycles.*
- *Available versions: for aluminum frames, 155° angled, without spring.*
- *Available in option: clip-on, twin and recessed.*
- *Clip-on type guide.*
- *Available in two colours: nickel and black*

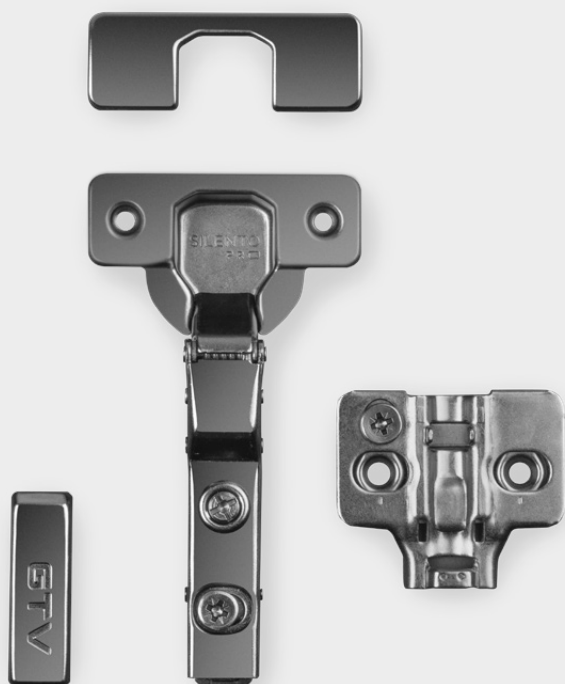

Informacje techniczne na str. 133
Technical information on page 133

Zawiasy to w rzeczywistości skomplikowane i precyzyjne konstrukcje, złożone z wielu elementów. Wszystkie muszą współpracować, by zapewnić niezawodność i komfort na co dzień.

Hinges are in fact complex and precise structures, made up of many components. They all need to work together to ensure reliability and comfort on a daily basis.

Zawiasy SILENTO PRO to cisi bohaterowie naszych mebli – ich zadanie to bezawaryjne działanie przez wiele lat. *SILENTO PRO hinges are the silent protagonists of our furniture - their job is to function faultlessly for many years.*

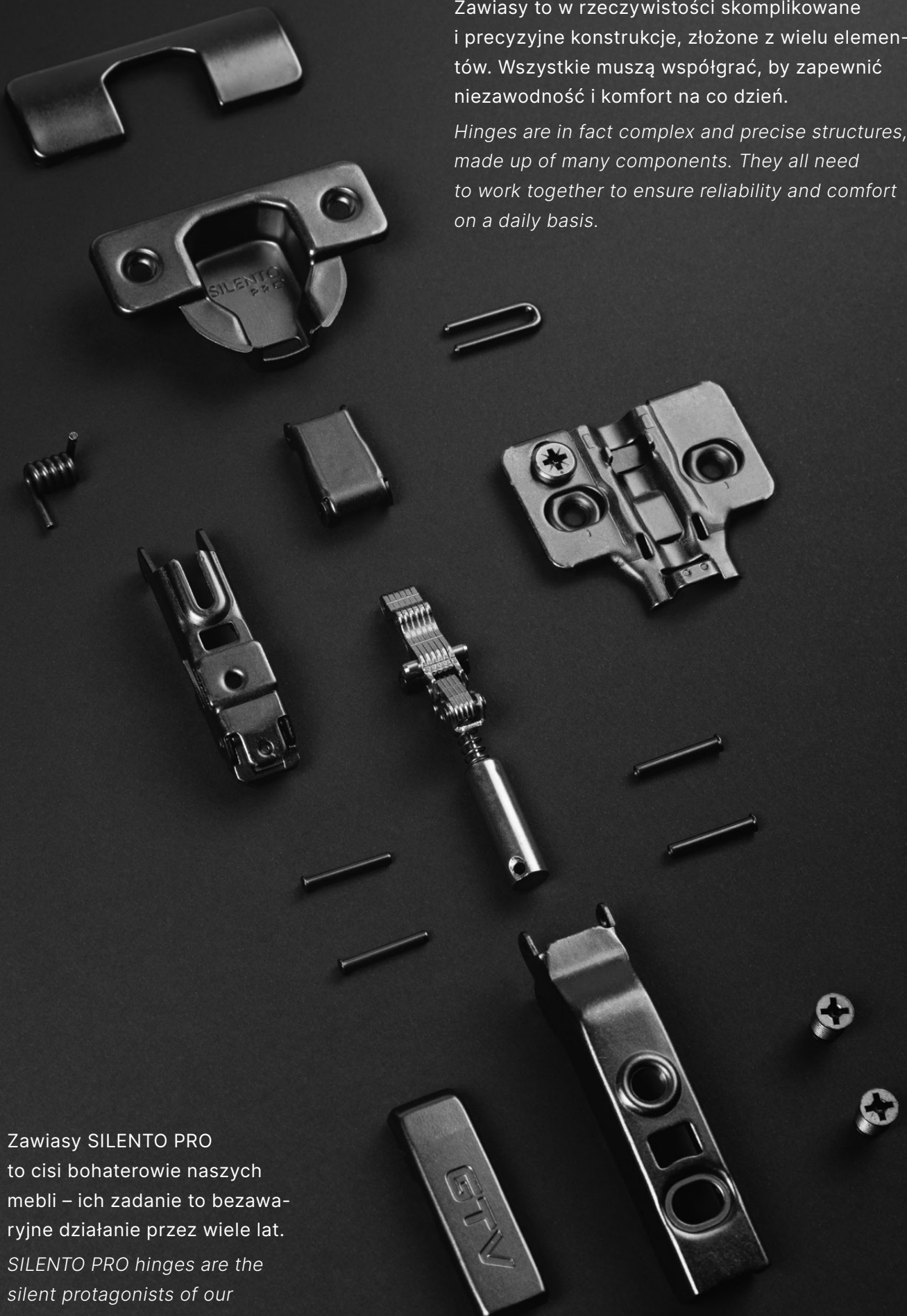



ZM-EHC09BEO

zawiasy

SOLID PLUS (DCHC)

hinges SOLID PLUS (DCHC)

Zawiasy z serii Solid Plus zostały wyposażone w technologię cichego domykania, która zapewnia płynne i bezawaryjne zamykanie. Dzięki regulacji w trzech płaszczyznach oraz mimośrodowej regulacji wysokości i głębokości umożliwia precyzyjne dopasowanie podczas montażu.

The hinges of the Solid Plus range are equipped with silent closing technology, which ensures smooth and trouble-free closing. Thanks to its adjustment in three planes and eccentric height and depth adjustment, it allows precise adjustment during installation.



Informacje techniczne na str. 143
Technical information on page 143



ZM-HCKT155BE

zawiasy ECHC

hinges ECHC

Zawiasy ECHC to wysokiej jakości produkty o trwałości certyfikowanej na 80 000 cykli, wyposażone w cichy domyk. Regulacja w trzech płaszczyznach umożliwia precyzyjne dopasowanie podczas montażu, a zastosowanie technologii clip-on ułatwia szybki montaż i demontaż frontu.

ECHC hinges are high-quality products with a certified durability of 80,000 cycles and equipped with a silent closure. Adjustment in three planes allows a precise fit during assembly, and the use of clip-on technology facilitates quick front assembly and removal.

⊕ Informacje techniczne na str. 141
Technical information on page 141



ZM-DCHC09-3DBEO

zawiasy HCKT

hinges HCKT

Zawiasy kątowe z serii HCKT zapewniają szeroki kąt otwarcia oraz komfort użytkowania dzięki zintegrowanemu systemowi cichego domyku. Dwustopniowa praca sprężyny chroni ściany i sąsiadujące meble, a montaż ułatwia prowadnik clip-on oraz mimośrodowa regulacja głębokości.

The angle hinges of the HCKT series provide a wide opening angle and comfort thanks to the integrated soft-closing system. The two-stage spring action protects the walls and adjacent furniture, and installation is facilitated by a clip-on guide and eccentric depth adjustment.

⊕ Informacje techniczne na str. 144
Technical information on page 144

Podnośniki

Lifts

Niezawodne mechanizmy ułatwiające otwieranie i zamykanie szafek górnych.

Reliable mechanisms for easy opening and closing of upper cabinets..







podnośnik HORIZON

lift HORIZON

Nowy standard komfortu w górnych szafkach.

A new standard of comfort in upper cabinets.

Podnośnik HORIZON to produkt, który zmienia sposób, w jaki korzystamy z górnych szafek kuchennych. Jego wyjątkowa mechanika zapewnia nie tylko płynny ruch, ale również efektywną amortyzację przy zamykaniu, co w znacznym stopniu zwiększa komfort użytkownika.

The HORIZON lift is a product that changes the way we use our upper kitchen cabinets. Its unique mechanics ensure not only smooth movement, but also effective cushioning when closing, which greatly enhances user comfort.

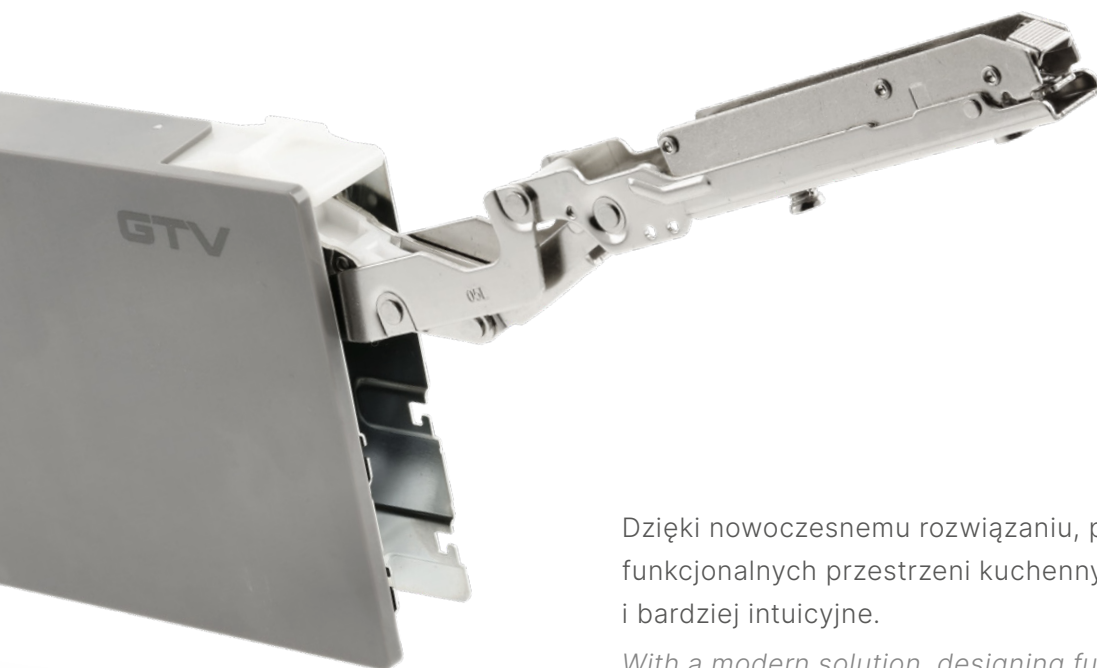

Dzięki nowoczesnemu rozwiązaniu, projektowanie funkcjonalnych przestrzeni kuchennych staje się prostsze i bardziej intuicyjne.

With a modern solution, designing functional kitchen spaces becomes simpler and more intuitive.

Płynność, amortyzacja, siła.

Smoothness, cushioning, force.





Podnośnik HORIZON soft close oraz push to open doskonale sprawdzi się w szafkach o wysokości od 300 mm do 650 mm.

Wyjątkowa konstrukcja umożliwia zatrzymywanie kłapy szafki w dowolnym położeniu, zapewniając pełną kontrolę i dostosowanie do potrzeb użytkownika. Dodatkowo, urządzenie w wersji soft close oferuje trzy rodzaje regulacji: siły działania, czasu domknięcia oraz kąta otwarcia, który może wynosić od 90° do 105°.

Dodatkowym atutem są trzy dostępne warianty kolorystyczne zaślepek – biały, antracyt oraz czarny – które umożliwiają idealne wpasowanie w estetykę każdej kuchni. Prosty montaż, nie wymagający użycia dodatkowych szablonów czy pomiarów, gwarantuje szybką i bezproblemową instalację.

The HORIZON soft close and push to open lift is ideal for cabinets from 300 mm to 650 mm in height.

The unique design allows the cabinet flap to be stopped in any position, providing complete control and customisation. Additionally, the device in the soft close version offers three types of adjustment: operating force, closing time, and opening angle, which can range from 90° to 105°.

An additional advantage are the three available colour variants of the end caps - white, anthracite and black - which enable them to fit perfectly into the aesthetics of any kitchen. Simple assembly, requiring no additional templates or measurements, guarantees a fast and trouble-free installation.

- Jakość produktu potwierdzona certyfikatem SGS na 40 000 cykli.
- Występuje w dwóch wersjach soft close oraz push to open.
- Prosty montaż bez potrzeby stosowania szablonu.
- Nie wymaga stosowania zawiasów.
- *Product quality certified by SGS for 40,000 cycles.*
- *It comes in two versions: soft close and push to open.*
- *Simple installation without the need for a template.*
- *No hinges required.*

podnośnik

MINILIFT NEW

lift MINILIFT NEW

Podnośnik MINILIFT NEW to kluczowy element nowoczesnych i funkcjonalnych szafek górnych, zapewniający płynne otwieranie z amortyzacją oraz możliwość zatrzymania klapy w dowolnej pozycji. Regulacja siły ramienia ułatwia montaż i dopasowanie do wybranego frontu.

The MINILIFT NEW lift is a key component of modern and functional upper cabinets, providing smooth opening with cushioning and the ability to stop the flap in any position.

The adjustable arm strength makes it easy to fit and adjust to the front of your choice.



Informacje techniczne na str. 149
Technical information on page 149



Przeznaczony do szafek o wysokości frontu do 550 mm, oferuje trzy warianty siły oraz orientacyjny kąt otwarcia 100°. Wykonany ze stali, dostępny jest w dwóch eleganckich kolorach – chrom i czarny.

Designed for cabinets with a front height of up to 550 mm, it offers three force variants and an indicative opening angle of 100°. Made of steel, it is available in two elegant colours - chrome and black.

Pozostałe akcesoria meblowe do szafek

Other furniture accessories for cabinets

Praktyczne
dodatki, które
wspierają
funkcjonalność
i wykończenie
mebli.

*Practical additions that support the functionality
and finish of the furniture.*







odbojniki

SALTO NOVA

bumpers SALTO NOVA

Świetnie sprawdzają się w systemach push to open oraz przy zawiasach samootwierających, zapewniając wygodę i płynność działania.

Dostępne w wersji wpuszczanej i nakładanej, z końcówką gumową lub magnetyczną.

Dzięki możliwości wyboru długości i koloru, można je łatwo dopasować do różnych projektów meblowych.

They are great for push-to-open systems and self-opening hinges, providing convenience and smooth operation. Available in recessed and overlay versions, with rubber or magnetic end. With a choice of length and colour, they can be easily adapted to different furniture designs.

Odbojniki SALTO NOVA to praktyczne rozwiązanie do nowoczesnych kuchni z frontami bezuchwytowymi, które zapewnia wygodne otwieranie szafek po lekkim naciśnięciu.

SALTO NOVA bumpers are a practical solution for modern kitchens with handleless fronts, ensuring that cabinets can be opened comfortably with a light press.



- Idealny do rozwiązań bezuchwytowych.
- Jakość potwierdzona certyfikatem SGS na 100 000 cykli.
- Dostępne warianty kolorystyczne: biały, szary, antracyt, czarny.
- Dostępny w dwóch długościach.
- *Ideal for handleless solutions.*
- *Quality certified by SGS for 100,000 cycles.*
- *Colour variants available: white, grey, anthracite, black.*
- *Available in two lengths.*





KRATKI WENTYLACYJNE

plinth vents

W poszukiwaniu wizualnego ładu i w celu nadania jednolitego, spójnego stylu, należy pamiętać nawet o tak niepozornych elementach wyposażenia wnętrza jak kratka wentylacyjna. Warto postawić na eleganckie, aluminiowe kratki w uniwersalnej kolorystyce, dopasowanej do standardowych kolorów mebli.

In the search for visual order and in order to give a uniform, consistent style, even such inconspicuous interior fittings as the ventilation grille should be kept in mind. It is worth opting for elegant aluminium grilles in versatile colours to match standard furniture colours.

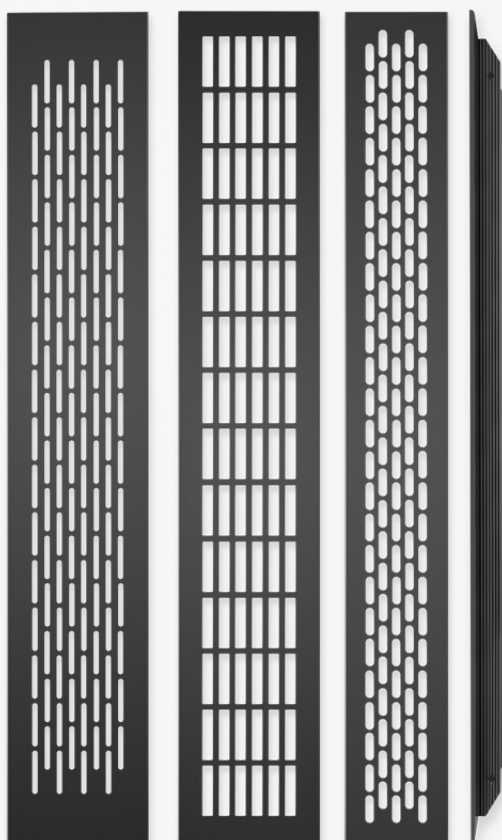

- Dostępne w kolorach: aluminium, stal szorstkowana, biały, złoty, czarny, antracyt.
- Przekrój wentylacyjny kratki wynosi od 40 do 146 cm².
- *Available in aluminium, brushed steel, white, gold, black, anthracite.*
- *The ventilation cross-section of the grilles ranges from 40 to 146 cm².*





KK-W60800-M0

Kratki wentylacyjne przeznaczone są do mebli wymagających cyrkulacji, w celu zapobiegania ich przegrzewaniu się oraz osadzaniu się w ich konstrukcji wilgoci. Doskonale sprawdzają się przy montażu sprzętów w zabudowie kuchennej – np. przy lodówce i piekarniku.

Ventilation grilles are designed for furniture that requires circulation, in order to prevent it from overheating and moisture from settling into its structure. They are ideal for installing appliances in built-in kitchens - e.g. refrigerators and ovens.

Harmonijne uzupełnienie wnętrza.

A harmonious addition to the interior.

⊕ Informacje techniczne na str. 154
Technical information on page 154





ELEMENTY ŁĄCZENIOWE

connecting elements

Niezbędne akcesoria, które zapewniają stabilność i trwałość konstrukcji meblowych.

Essential accessories that ensure the stability and durability of furniture structures.



Listwa montażowa

Fixed plate

Praktyczne rozwiązanie do montowania szafek wiszących. Kompatybilna z zawieszkami FORZA, R1 i R0, wykonana ze stali, dostępna w długości 2000 mm i grubości 1,2 mm.

A practical solution for mounting wall cabinets. Compatible with FORZA, R1 and R0 hangers, made of steel, available in 2000 × 600 mm.



Zawieszka meblowa FORZA

FORZA furniture hanger

Idealna do montażu szafek wiszących. Zapewnia udźwig do 150 kg przy użyciu dwóch sztuk. Regulacja w dwóch płaszczyznach i łatwy montaż gwarantują stabilność i komfort użytkowania.

Ideal for installation of wall cabinets. Provides a lifting capacity of up to 150 kg with two pieces. Two-plane adjustment and easy installation guarantee stability and comfort.



Zaślepka do zawieszki FORZA

End cap for FORZA hanger

Praktyczne uzupełnienie zawieszki, które chroni mechanizm przed wilgocią i zabrudzeniami. Dostępna w dwóch uniwersalnych kolorach: białym i czarnym.

A practical addition to the hanger that protects the mechanism from moisture and dirt. Available in two universal colours: white and black.





NÓŻKI COKOŁOWE

plinth legs

Stosowane głównie w meblach kuchennych i biurowych nóżki cokołowe podnoszą korpus mebla umożliwiając montaż listwy cokołowej. Chronią również dolne części mebli przed uszkodzeniami, wilgocią czy zabrudzeniami. Wykonane są z tworzywa, dostępne w kilku rozmiarach, aby pasować do różnych stylów i potrzeb.

Mainly used in kitchen and office furniture, plinth legs raise the body of the furniture above the floor. They also protect the lower parts of the furniture from damage, moisture or dirt. They are made of plastic and are available in a variety of sizes to suit different styles and needs.



Informacje techniczne na str. 157
Technical information on page 157

nóżki z regulacją

MLA

adjustable legs MLA

Nóżka MLA ma zapewnić równowagę i odpowiednie podparcie konstrukcji. Nóżka składa się z trzech głównych części: górnej z czterema otworami i żebrami wzmacniającymi, środkowej cylindrycznej z gwintem wewnętrznym oraz stopy w dolnej części o średnicy 80 mm z gwintem zewnętrznym na bolcu. Dzięki takiej konstrukcji nóżka jest w stanie przyjąć obciążenie do 450 kg.

The MLA leg is designed to provide balance and proper support for the structure. The leg consists of three main parts: an upper part with four holes and reinforcing ribs, a central cylindrical part with an internal thread and a foot in the lower part with an 80 mm diameter external thread on the bolt. Thanks to this design, the leg is able to take a load of up to 450 kg.

klip cokołowy do nóżki
plinth clip for leg

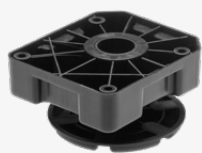

50-75

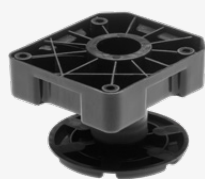

65-85



85-125



95-145



125-195

nóżki z regulacją DPD

adjustable legs DPD

Przeznaczone do montażu mebli z cokołem w celu tworzenia dystansu między szafką a podłogą oraz do wyrównywania szafek na długich odcinkach i stabilizowania obciążeń. Przyjmują obciążenie do 60 kg.

Designed for assembling furniture with a plinth to create a distance between the cabinet and the floor, and for aligning cabinets over long distances and stabilising loads. They can withstand loads of up to 60 kg.



klip cokołowy do nóżki.
plinth clip for leg

nóżki DPA

legs DPA

Stworzone do instalacji mebli z cokołem, aby zapewnić odstęp między szafką a podłogą oraz do poziomowania szafek na dłuższych dystansach i stabilizacji obciążenia. Może znieść obciążenie do 100 kg.

Created for the installation of pedestal furniture to provide clearance between the cabinet and the floor, and for levelling cabinets over longer distances and stabilising the load. It can bear a load of up to 100 kg.



klip cokołowy do nóżki.
plinth clip for leg

Klucz do regulacji nóżek DPD / DPA

DPD / DPA leg adjustment spanner

Służy jako narzędzie pomocnicze podczas regulacji wysokości nóżek meblowych. Posiada perforowany uchwyt i hak, który umożliwia wygodną regulację wysokości podpórki.

Serves as an auxiliary tool when adjusting the height of furniture legs. It has a perforated handle and a hook that allows the height of the support to be conveniently adjusted.



Systemy bezuchwytowe

Handleless systems

Minimalistyczna
przestrzeń
i równowaga
w detalach nadal
są w trendach.

*Minimalist space and balance in details
are still on trend.*





system bezuchwytowy **VELLO**

handleless system VELLO

System bezuchwytowy VELLO to zestaw poziomych i pionowych profili w pięciu konfiguracjach i modnych kolorach. Za jego pomocą można łatwo zbudować nowoczesną i funkcjonalną kuchnię.

The VELLO handleless system is a set of horizontal and vertical profiles in five configurations and fashionable colours. With its help you can easily build a modern and functional kitchen.

 Informacje techniczne na str. 159
Technical information on page 159



Idealny kształt profilu zapewnia łatwy dostęp do zawartości szafek kuchennych.

The ideal profile shape ensures easy access to the contents of the kitchen cabinets.





Najwyższy komfort bez zbędnych detali.

Ultimate comfort without unnecessary detail.



Montowane między frontami szuflad i szafek profile VELLO, są alternatywą dla tradycyjnych uchwytów meblowych. Dzięki nim korzystanie z mebli kuchennych staje się wygodniejsze. Profile VELLO dostępne są w pięciu uniwersalnych wersjach kolorystycznych: biel, czerń, aluminium, jasne złoto i stal szczotkowana, które idealnie komponują się z frontami kuchennymi w podobnej kolorystyce.

Mounted between drawer and cabinet fronts, Vello profiles are an alternative to traditional furniture handles. They make the use of kitchen furniture more convenient. Vello profiles are available in five universal colour versions: white, black, aluminium, bright gold and brushed steel, which blend in perfectly with kitchen fronts in similar colours.

**Typ L** horyzontalny jednostronny, z funkcją oświetlenia LED

L = 3 m: aluminium, czarny matowy, biały, stal szczotkowana

L = 4,1 m: aluminium, czarny matowy, biały, stal szczotkowana, złoty

*Type L horizontal single-sided, with LED lighting function**L = 3 m: aluminium, matt black, white, brushed steel**L = 4.1 m: aluminium, matt black, white, brushed steel, gold***Typ C** horyzontalny dwustronny, z funkcją oświetlenia LED

L = 3 m: aluminium, czarny mat, biały, stal szczotkowana

L = 4,1 m: aluminium, czarny mat, biały, stal szczotkowana, złoty

*Type C horizontal double-sided, with LED lighting function**L = 3 m: aluminium, matt black, white, brushed steel**L = 4.1 m: aluminium, matt black, white, brushed steel, gold***Typ TJ** wertykalny pojedynczy

L = 3 m: aluminium, czarny mat, biały, stal szczotkowana, złoty

*Type TJ vertical single**L = 3 m: aluminium, matt black, white, brushed steel, gold***Typ TD** wertykalny podwójny

L = 3 m: aluminium, czarny mat, biały, stal szczotkowana, złoty

*Type TD vertical double**L = 3 m: aluminium, matt black, white, brushed steel, gold***Profil wieńcowy**

L = 3 m: aluminium, biały, czarny mat, złoty

Do płyty o grubości 16 mm i 18 mm

*Rim profile**L = 3 m: aluminium, white, matt black, gold**For 16 mm and 18 mm board thickness*

Oświetlenie meblowe

Furniture lighting

Funkcjonalne
oświetlenie LED,
które kształtuje
wnętrze.

Functional LED lighting that shapes the interior.







profile LED **GLAX**

LED profiles GLAX

Coraz popularniejsze w kuchniach taśmy LED pozwalają na stworzenie niezwykłych aranżacji świetlnych. Aby jednak osiągnąć efekt profesjonalnie wykończonej instalacji, warto zainwestować w profile GLAX, które zapewniają estetyczne wykończenie.

LED strips, which are becoming increasingly popular in kitchens, make it possible to create unusual lighting arrangements. However, to achieve the effect of a professionally finished installation, it is worth investing in GLAX profiles, which provide an aesthetically pleasing finish.



W czasie pracy taśma LED generuje ciepło, które należy z niej odprowadzić. W tym celu stosuje się specjalne, aluminiowe profile GLAX.

Profile do taśm LED świetnie sprawdzą się jako oświetlenie podszafrkowe w kuchni, oświetlając blat roboczy oraz dostrajając wnętrze niezależnie od jego stylu. W ofercie znajdują się profile wpuszczane, nakładane, kątowe i z regulowanym kątem światła.

During operation, the LED strip generates heat, which must be dissipated from it. Special GLAX aluminium profiles are used for this purpose.

LED strip profiles are great for under-cabinet lighting in the kitchen, illuminating the worktop and fine-tuning the interior regardless of its style. The range includes recessed, overlay angled and with adjustable light angle.



Informacje techniczne na str. 167
Technical information on page 167

Kuchnia w dobrym świetle.

Kitchen in good light.



PROFIL NAKŁADANY

overlay profile

Profile nakładane są jednymi z najchętniej wybieranych produktów ze względu na ich wszechstronność i łatwość montażu.

Dostępne są w różnorodnych wariantach, takich jak kątowe, mini i micro czy wysokie oraz w szerokiej palecie barw. Pozwalają na stworzenie unikalnego, spersonalizowanego wyglądu.

Idealne dla tych, którzy cenią sobie minimalistyczny styl i innowacyjne rozwiązania w aranżacji przestrzeni.

Overlay profiles are among the most popular products due to their versatility and ease of installation.

They are available in a variety of variants such as angular, mini and micro or tall and in a wide range of colours. They allow you to create a unique, personalised look.

Ideal for those who appreciate minimalist style and innovative solutions in space design.

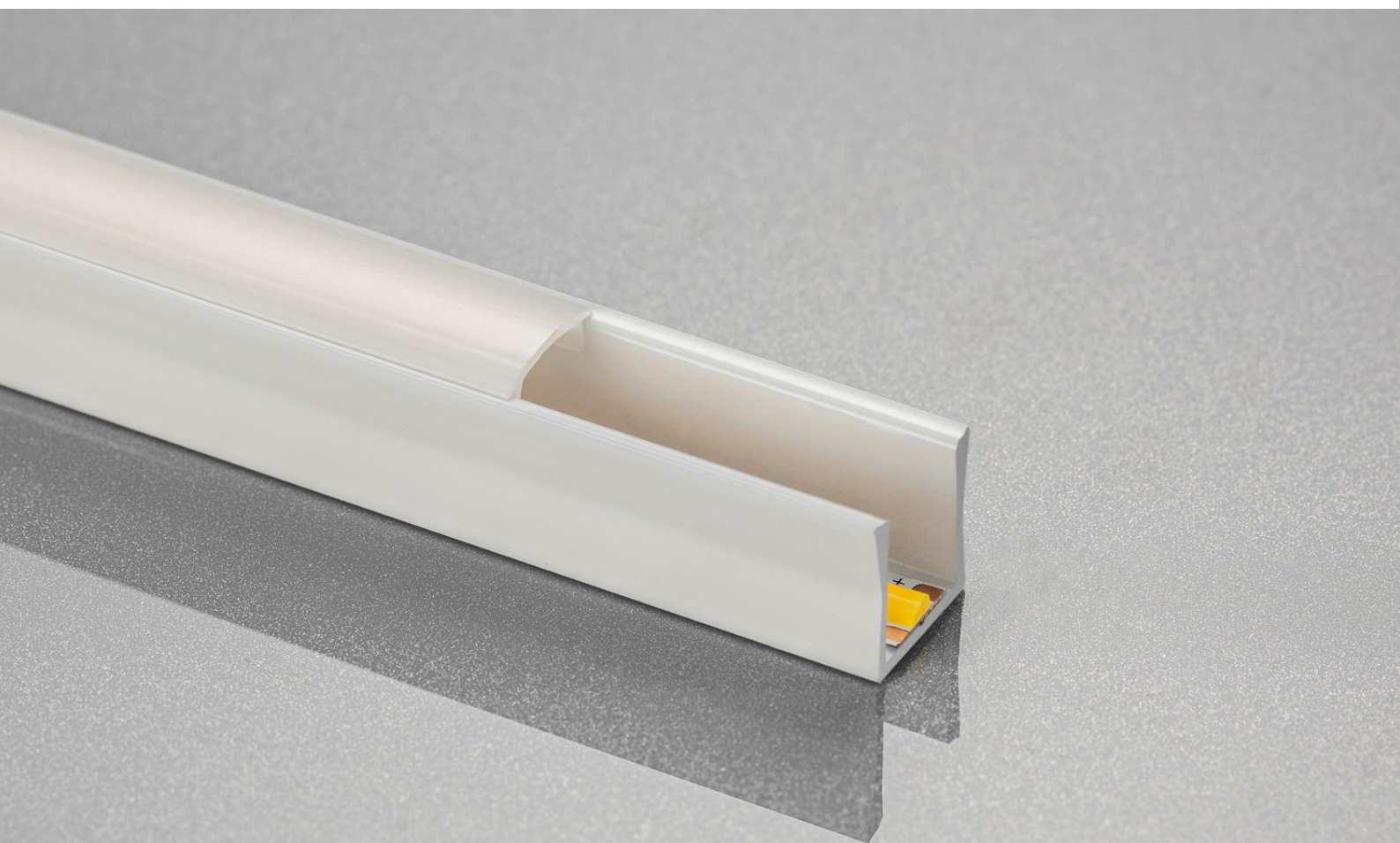

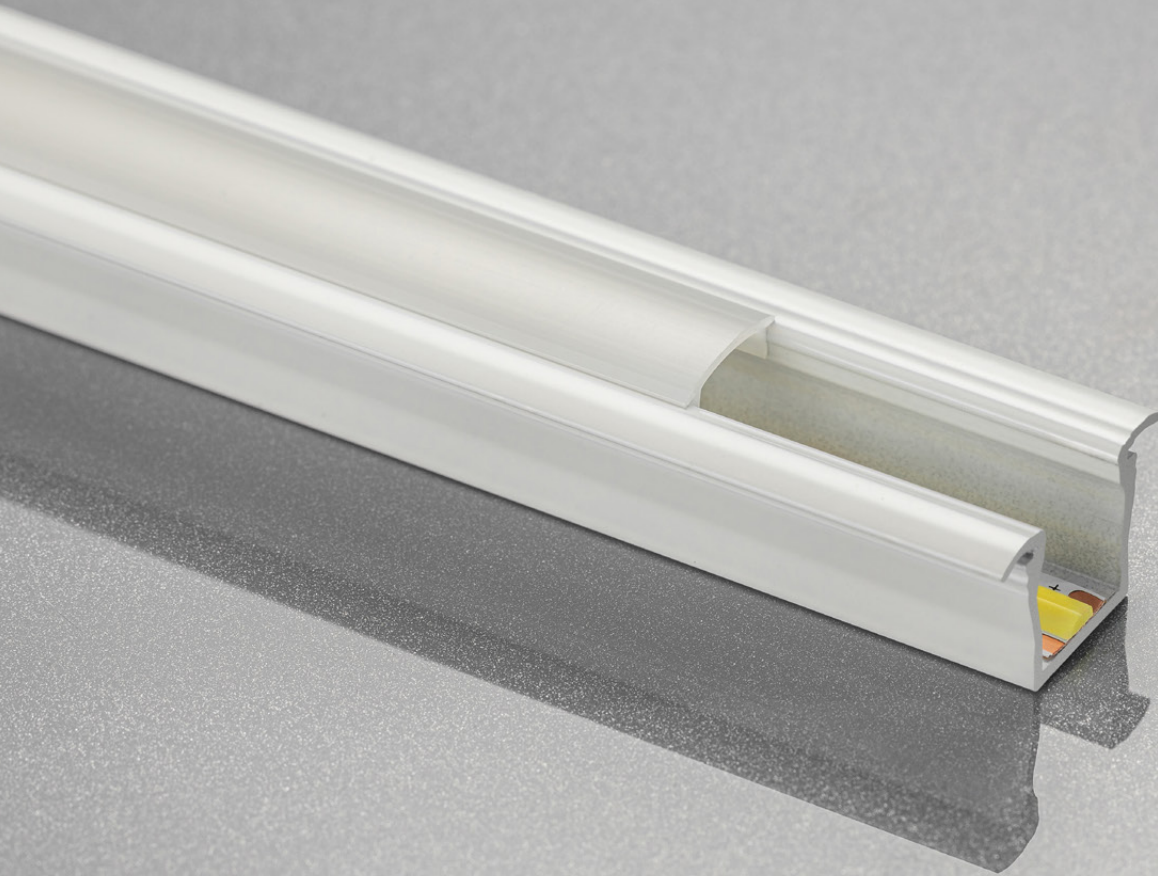

PA-GLAXMW-AL-10

PROFIL WPUSZCZANY

recessed profile

Profil wpuszczany GLAX to idealne rozwiązanie dla tych, którzy pragną stworzyć wyrefinowaną i subtelną atmosferę w swoich wnętrzach. Zapewnia miękkie, równomierne światło bez widocznych punktów świetlnych, co podkreśla minimalistyczny design i perfekcję wykonania.

Wpuszczany profil GLAX to wybór perfekcjonistów poszukujących nowoczesnych i funkcjonalnych rozwiązań.

The GLAX recessed profile is the ideal solution for those who want to create a sophisticated and subtle atmosphere in their interiors. It provides soft, even light without any visible points of light, which emphasises the minimalist design and perfection of the workmanship.

The recessed Glax profile is the choice of perfectionists looking for modern and functional solutions.

PROFIL KĄTOWY

angle profile

Profil kątowy stosowany jest w narożnikach zabudowy meblowej, najczęściej pod szafkami wiszącymi w kuchni.

W przypadku profilu kąтового nakładanego stosuje się specjalne uchwyty montażowe, posiadające małe, zakrzywione do środka blaszki, które utrzymują profil na miejscu. Zaleca się, aby odległość między chwytami nie była większa niż jeden metr.

The angle profile is used in the corners of furniture fittings, most often under wall cabinets in the kitchen.

Special mounting brackets are used for the overlapping angle profile, which have small, inwardly curved plates that hold the profile in place. It is recommended that the distance between grabs should be no more than one metre.

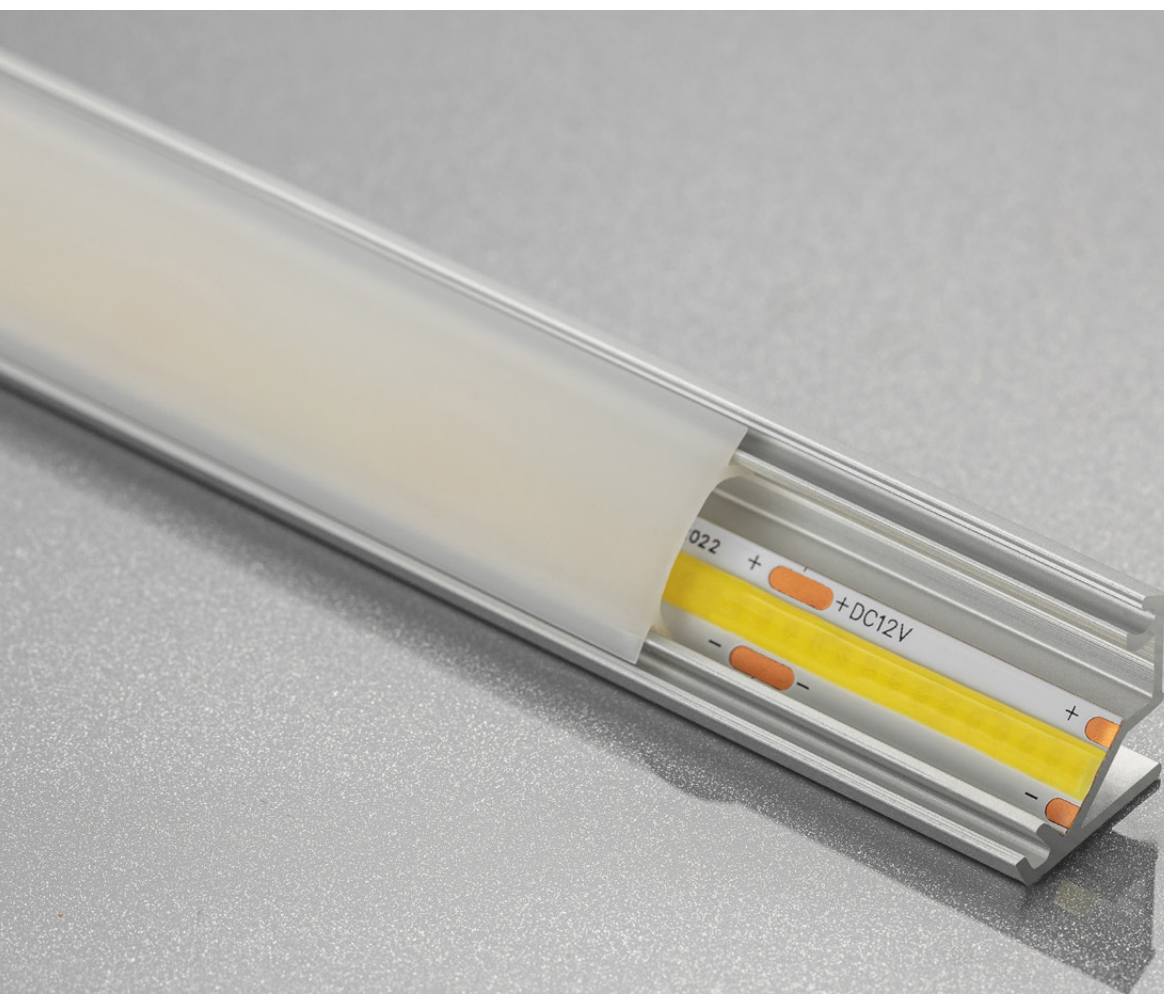

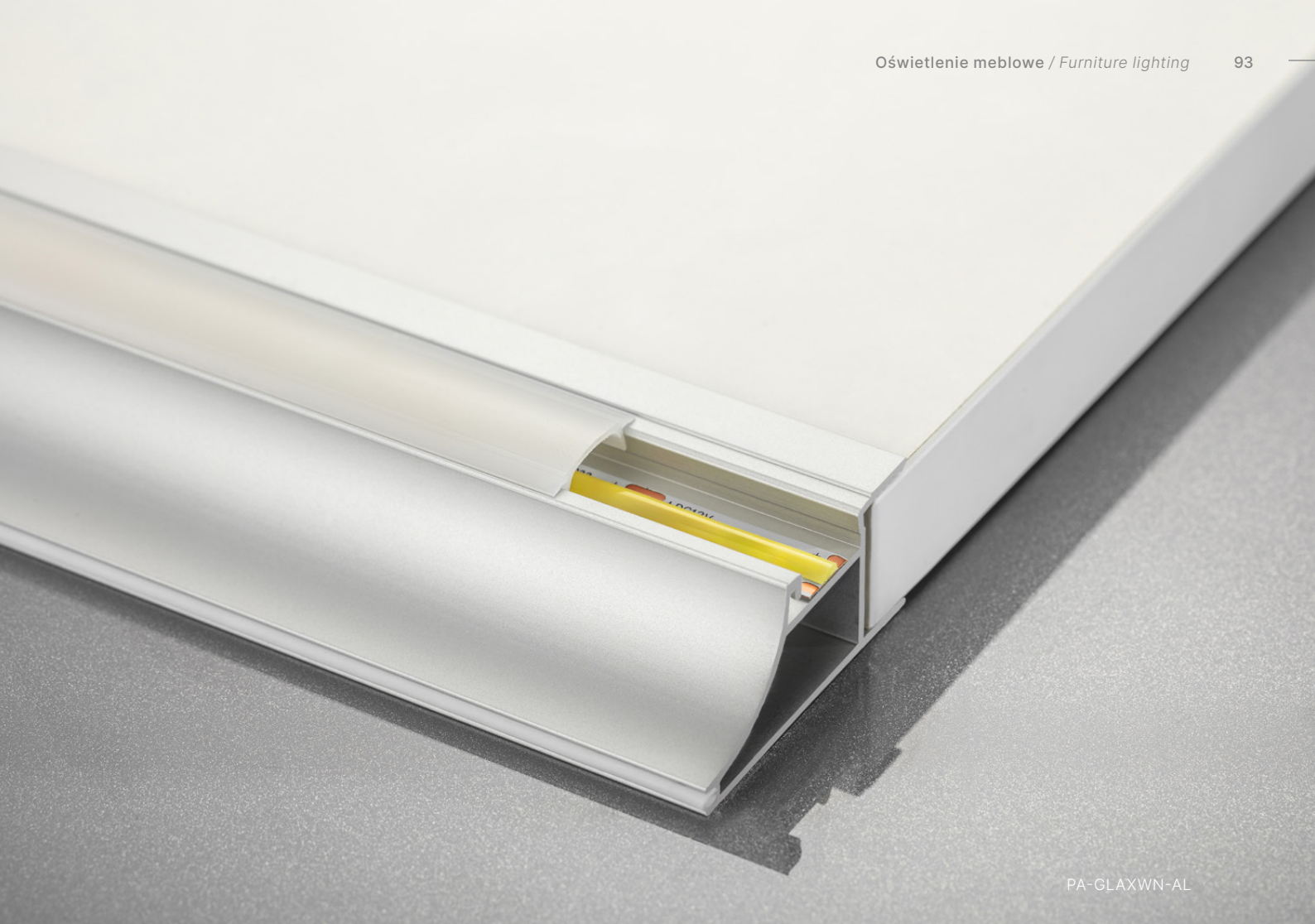

PA-GLAXWN-AL

PROFIL WIEŃCOWY

rim profile

Profil wieńcowy należy do rodziny profili nabijanych, dlatego przy ich doborze należy zwrócić uwagę na grubość płyty, z jakiej wykonany jest wieniec.

Profil może być stosowany z płytą o grubości 18 mm. Przy planowaniu szafki należy pamiętać, aby dolny wieniec był cofnięty o 33 mm względem korpusu.

Profile wieńcowe stosowane są najczęściej w wiszących szafkach kuchennych i pełnią podwójną funkcję: oświetlają przestrzeń roboczą, jednocześnie zastępując uchwyt do otwierania frontu. Takie rozwiązanie spotkać można w zabudowach opartych o systemy push to open. Gumka montowana w specjalnej przegrodzie na przodzie profilu zabezpiecza front i niweluje odgłos jego zamykania.

The rim profile belongs to the family of knock-in profiles, so when selecting it, attention should be paid to the thickness of the board from which the rim is made.

The profile can be used with a panel thickness of 18 mm. When planning a cabinet, it is important to ensure that the bottom panel is set back 33 mm from the cabinet.

Rim profile are most often used in wall-mounted kitchen cabinets and serve a double function: they illuminate the workspace while also replacing the handle for opening the front. Such a solution can be found in buildings based on push-to-open systems. A rubber seal mounted in a special compartment at the front of the profile protects the front and eliminates the noise of closing.



TAŚMY LED

LED strips

Taśmy LED znajdują wiele zastosowań we wnętrzach, a szczególnie popularne stały się w kuchniach. Dostępne są w 3 barwach światła: zimnej, ciepłej i neutralnej.

Ich zaletą jest energooszczędność, łatwy montaż i możliwości tworzenia nastrojowego lub funkcjonalnego oświetlenia w dowolnej przestrzeni.

LED strips find many applications in interiors, and have become particularly popular in kitchens. They are available in 3 light colours: cold, warm and neutral.

Their advantages include energy efficiency, easy installation, and the ability to create ambient or functional lighting in any space.

Taśmy LED COB

LED COB strips

W odróżnieniu od tradycyjnych taśm opartych na diodach SMD, gdzie widoczne są punkty świetlne, taśmy w technologii COB tworzą równą linię światła bez widocznych punktów. Taki efekt zawdzięczamy bardzo gęsto ułożonym diodom. Dla wygody użytkowników każdy z 5-metrowych odcinków zakończony jest z obu stron 1-metrowym przewodem ze złączką miniAMP. Taśma może być cięta co 5 cm.

LED COB strips Unlike traditional strips based on SMD LEDs, where the light points are visible, COB strips create an even line of light with no visible points. This effect is due to the very densely arranged diodes. For users' convenience, each of the 5-metre sections is terminated on both sides by a 1-metre cable with a mini AMP connector. The tape can be cut every 5 cm.



Taśma LED FLASH

LED FLASH strip

Tradycyjne taśmy LED, takie jak FLASH, wykorzystują pojedyncze diody LED rozmieszczone w równych odstępach na elastycznym pasku. Taśma LED Flash to rozwiązanie, które dostarcza intensywne, ale jednocześnie energooszczędne światło. Ważnym parametrem taśm LED jest gęstość ułożenia diod. Im gęściej są ułożone tym równiejsza linia światła.

Traditional LED strips, such as FLASH, use individual LEDs spaced at equal intervals on a flexible strip. LED Flash strip is a solution that provides intense yet energy-efficient light. An important parameter for LED strips is the density of the LEDs. The denser they are arranged, the more even the line of light.

ZASILACZE

power supplies

Zasilacze są kluczowym elementem każdego zestawu oświetleniowego. Ich głównym zadaniem jest przekształcanie napięcia z sieci elektrycznej na napięcie, które jest bezpieczne i optymalne dla taśm LED, co zwykle wynosi 12 V lub 24 V.

Power supplies are a key component of any lighting kit. Their main task is to convert the voltage from the mains to a voltage that is safe and optimal for LED strips, which is usually 12 V or 24 V.

⊕ Informacje techniczne na str. 181
 Technical information on page 181



Zasilacze LED EASY CLICK

EASY CLICK LED power supplies

- Obudowa w wersji SLIM.
- Filtr EMC i przeciwprzepięciowy.
- Pobór prądu w trybie czuwania poniżej 0,5 W.
- Przewód zasilający o długości 1,5 m.
- *SLIM version of the case.*
- *EMC and surge filter.*
- *Standby power consumption less than 0.5 W.*
- *Power cord - 1.5 m*

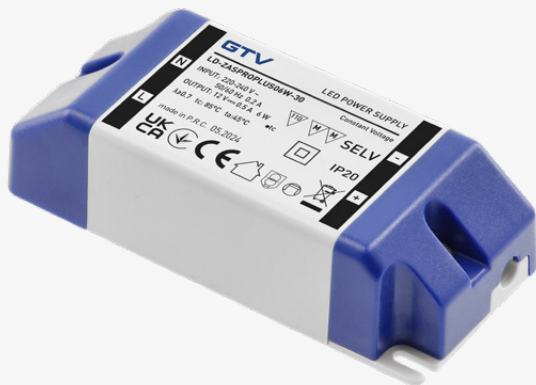
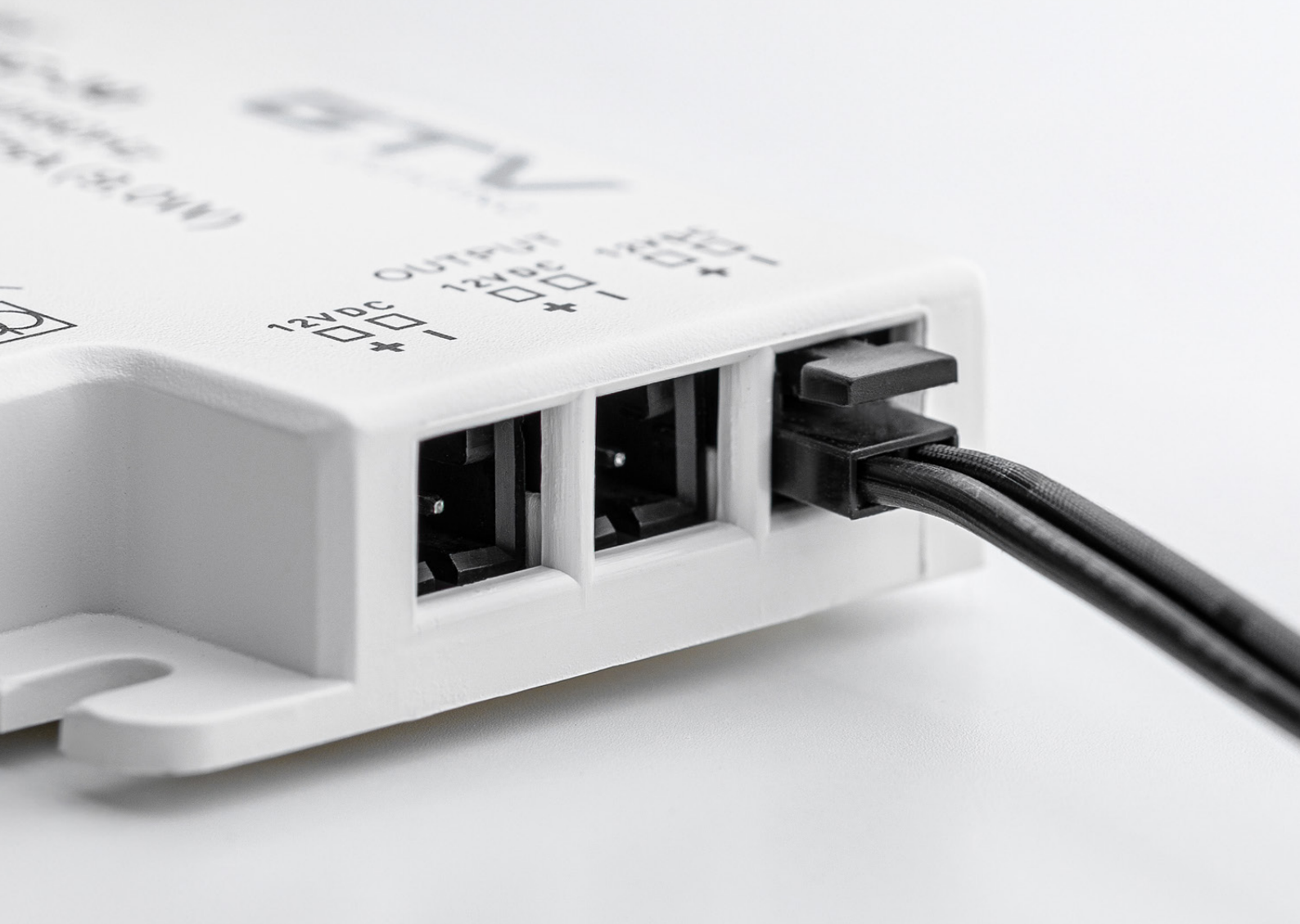

Zasilacze LED PRO+

LED PRO+ power supplies

- Filtr EMC.
- SELV – bardzo niskie napięcie bezpieczne.
- Zabezpieczenie przeciwprzeciężeniowe.
- Nie wydaje uciążliwych pisków.
- Niskie zużycie prądu w trybie „Standby”.
- *EMC filter.*
- *SELV - very safe voltage.*
- *Overload protection*
- *It does not make any annoying squeaks.*
- *Low power consumption in 'Standby'.*



AE-WBCUNI-10DIM

WŁĄCZNIKI

switches

Włączniki do oświetlenia meblowego to praktyczne i funkcjonalne rozwiązania umożliwiające łatwe sterowanie światłem w meblach, np. automatyczne włączanie go przy otwieraniu drzwi lub szuflad. Włączniki te nie tylko ułatwiają codzienne użytkowanie, ale także dodają elegancji i nowoczesności meblom, integrując oświetlenie z ich designem. Ich instalacja jest zwykle prosta i nie wymaga zaawansowanych modyfikacji mebli, co czyni je popularnym wyborem w nowoczesnych aranżacjach wnętrz.

Switches for furniture lighting are practical and functional solutions for easy control of light in furniture, such as automatically switching it on when doors or drawers are opened. These switches not only facilitate everyday use, but also add elegance and modernity to the furniture, integrating the lighting into its design. Their installation is usually straightforward and does not require advanced furniture modifications, making them a popular choice in modern interior design.



Informacje techniczne na str. 183
Technical information on page 183

Włącznik dotykowy bezprzewodowy on-off

Wireless touch on-off switch

To nowoczesne urządzenie umożliwiające sterowanie oświetleniem zasilanym prądem o napięciu 12-24V DC. Urządzenie składa się z dwóch elementów: kontrolera i włącznika, które komunikują się drogą radiową, co pozwala umieścić włącznik dosłownie wszędzie. Daje to dużą swobodę w umiejscowieniu włącznika w przestrzeni.

It is a state-of-the-art device for controlling lighting or other systems powered by 12-24V DC. The device consists of two components: a controller and a switch, which communicate by radio, allowing the switch to be placed literally anywhere. This gives a lot of flexibility in the location of the switch in the space.

AE-WDBP1-10



Najważniejsze zalety włącznika:

Key benefits of the switch:

- Łatwość instalacji: nie wymaga prowadzenia dodatkowych przewodów elektrycznych.
- Komfort użytkowania: możliwość sterowania oświetleniem za pomocą prostego dotknięcia.
- Elastyczność montażu: może być zamontowany w dowolnym miejscu, bez ograniczeń.
- Estetyka: nowoczesny design i możliwość dopasowania do różnych stylów wnętrz.
- *Ease of installation: no additional electrical wiring required.*
- *Convenience of use: lighting can be controlled with a simple touch.*
- *Flexible installation: can be installed anywhere, without restrictions.*
- *Aesthetics: modern design and adaptability to different interior styles.*



Włącznik bezdotykowy uniwersalny 3 w 1

3-in-1 contactless universal switch.

Może być stosowany jako włącznik tzw. drzwiowy i reagujący na ruch. W trybie dwubiegowym może pełnić również funkcję ściemniacza. Zasięg widzenia czujnika wynosi około 5-6 cm. Włącznik może być zasilany prądem 12 V lub 24 V. Maksymalne obciążenie włącznika przy zasilaniu 12 V wynosi 24 W, natomiast przy 24 V może obsłużyć do 48 W.

It can be used as a so-called door and motion-responsive switch. In two-speed mode, it can also act as a dimmer. The sensor's viewing range is approximately 5-6 cm. The switch can be powered by 12 V or 24 V. The maximum load for the switch when supplied with 12 V is 24 W, by contrast, at 24 V it can handle up to 48 W.



Włącznik dotykowy ściemniający

Dimmable touch switch

Jednym ze sposobów na ułatwienie codziennego funkcjonowania w nowoczesnej przestrzeni jest włącznik dotykowy z funkcją ściemniacza. Niewątpliwą zaletą jest jego niewielki rozmiar, porównywalny do guzika. W połączeniu z montażem wpuszczanym zapewnia to dużą dyskrecję i minimalistyczną estetykę.

One way to make everyday life in a modern space easier is with a touch switch with dimmer function. An undoubted advantage is its small size, comparable to a button. Combined with recessed mounting, this provides a highly discreet and minimalist aesthetic.

Włącznik dotykowy ściemniający RING

Dimmable touch switch RING

Funkcjonalny włącznik, w którym opcja ściemniania aktywowana jest poprzez jego dłuższe wciśnięcie. Estetyczne wykończenie w czerni z chromowaną obwódką i minimalistyczna forma czynią z włącznika uniwersalny element zabudowy.

A functional switch that makes everyday use of spaces where LED strips are installed more comfortable and customised. The dimming function is activated by pressing the switch for a longer period of time. The aesthetically pleasing finish in black with a chrome border and the minimalist form make the switch a versatile built-in element.

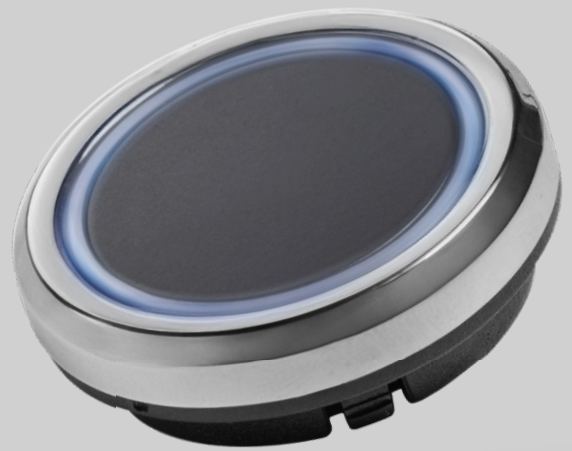

Włącznik dotykowy krawędziowy BORD

Touch-sensitive edge switch BORD

Służy do włączania, wyłączania i ściemniania opraw oświetleniowych LED i taśm LED. Poprzez krótkie dotknięcie powoduje zapalenie lub zgaszenie światła, a długi dotyk włącznika powoduje ściemnianie lub rozjaśnianie oświetlenia. Włącznik Bord przeznaczony jest do montażu pod blat i półkę.

It is used to switch on, switch off and dim LED luminaires and LED strips. A short touch turns the light on or off, while a long touch on the switch dims or brightens the lighting. The Bord switch is designed to be mounted under the countertop and shelf.

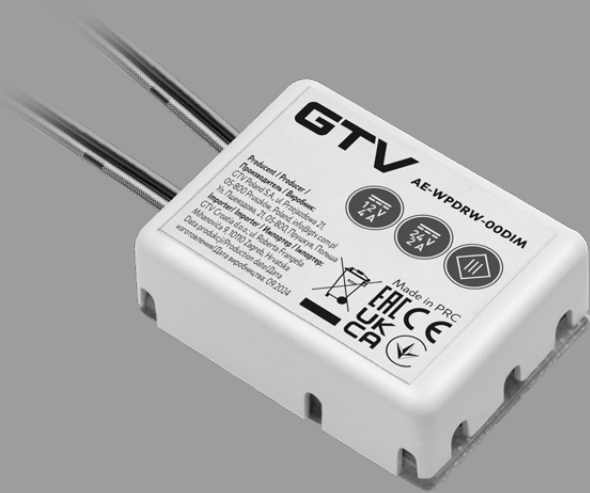

Włączanie i wyłączenie polega na dotknięciu blatu na wysokości montażu, a ściemnianie następuje poprzez dłuższe przytrzymanie dłoni w tym miejscu. Bardzo sprytne rozwiązanie dla wszystkich lubiących minimalizm. Produkt sprzedawany jest bez zasilacza. Po zamontowaniu czujnik jest całkowicie niewidoczny.

Switching on and off is done by touching the tabletop at mounting height, and dimming is done by holding the hand there for a longer period of time. A very clever solution for anyone who likes minimalism. The product is sold without a power supply unit. Once fitted, the sensor is completely invisible.

Włącznik podblatowy ściemniający

Undercounter dimmable switch

Włącznik umieszcza się pod blatem o maksymalnej grubości 40 mm.

The switch is placed under a countertop with a maximum thickness of 40 mm.

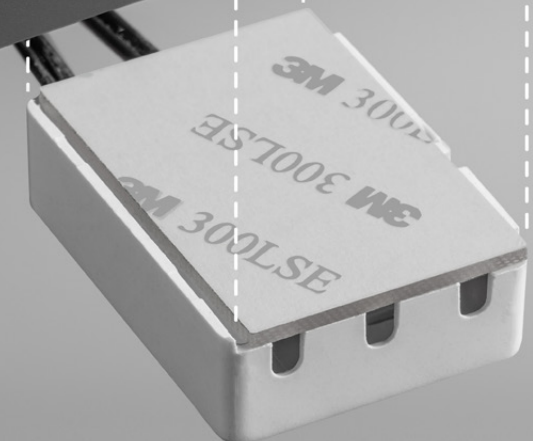

Włącznik bezdotykowy ściemniający do profili LED z konektorem COB

Non-contact dimmable switch for LED profiles with COB connector

Włącznik do montowania wewnątrz profilu, z jednej strony zakończony jest złączką COB, które umożliwia szybki montaż taśmy COB do włącznika. Obsługuje odcinki taśmy o mocy 36 W (wersja z przewodami) lub 60 W (wersja bez przewodu) dla 12 V oraz 72 W (wersja z przewodami) lub 120 W (wersja bez przewodu) dla 24 V. Przewód zakończony złączką mini amp co umożliwia szybkie i łatwe podłączenie do zasilacza Easy Click. Dostępna także opcja bez przewodu.

Switch to be mounted inside the profile, terminated on one side with a COB connector, which allows the COB strip to be quickly attached to the switch. It supports strip sections up to 36 W (wired version) or 60 W (wireless version) for 12 V, and up to 72 W (wired version) or 120 W (wireless version) for 24 V. The cable is finished with a mini amp connector, allowing quick and easy connection to the EASY CLICK power supply. A wireless option is also available.

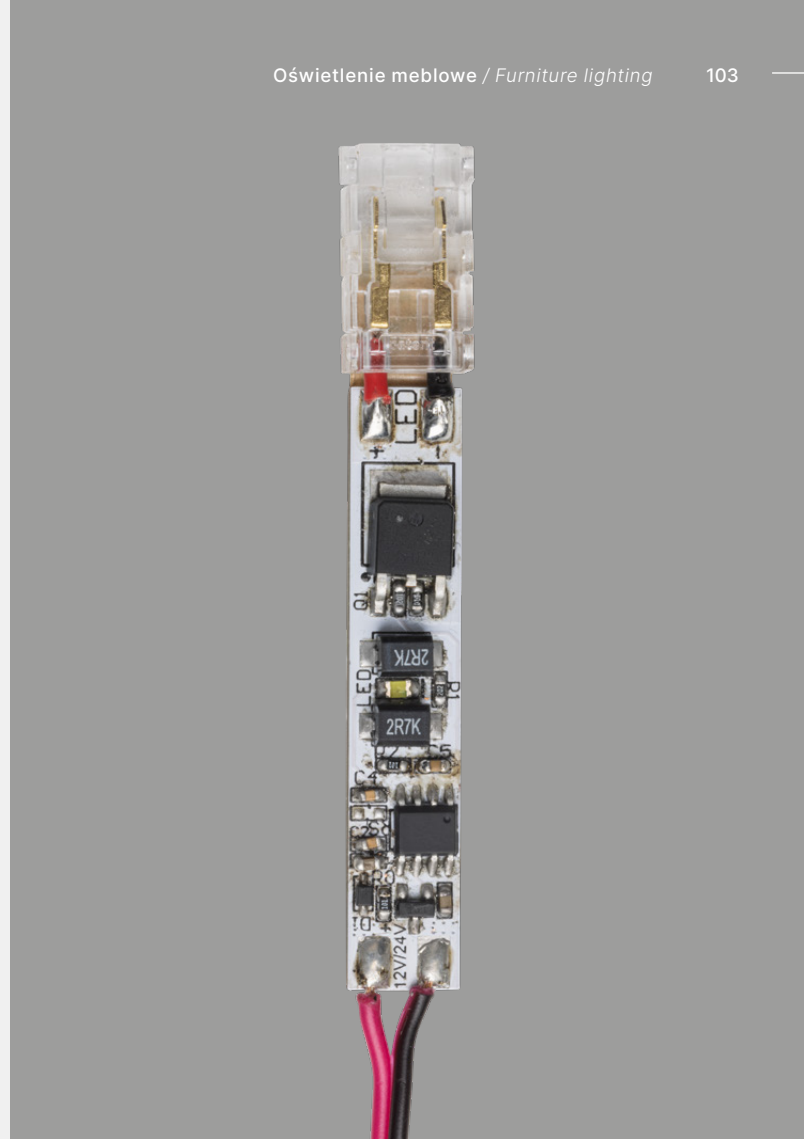

Włącznik bezdotykowy do profili LED

Touchless switch for LED profiles







Włącznik bezdotykowy do montowania wewnątrz profilu. Obsługuje odcinki taśmy o mocy nie większej niż 60 W. Nie posiada funkcji ściemniania. Opcja z przewodem 2 m lub bez. Przewód zakończony złączką mini amp co umożliwia szybkie i łatwe podłączenie do zasilacza EASY CLICK.

Touchless switch for mounting inside the profile. Supports tape sections of no more than 60 watts. No dimming function. Option with or without 2 m cable. The cable is finished with a mini amp connector, allowing quick and easy connection to the EASY CLICK power supply.









Systemy szuflad / Drawer systems

AXIS PRO / AXIS PRO



AXIS PRO soft close Komplet szuflady ekstra niskiej / AXIS PRO soft close Extra low drawer set

					
	PB-AXISPRO-KPL69-450-10	450	biały white	lakier lacquer	stal steel
	PB-AXISPRO-KPL69-500-10	500			
	PB-AXISPRO-KPL69-450-60	450	antracyt anthracite	lakier lacquer	stal steel
	PB-AXISPRO-KPL69-500-60	500			

AXIS PRO soft close Komplet szuflady niskiej "A" / AXIS PRO soft close Low drawer set "A"





					
	PB-AXISPRO-KPL250A1	250	biały white	lakier lacquer	stal steel
	PB-AXISPRO-KPL300A1	300			
	PB-AXISPRO-KPL350A1	350			
	PB-AXISPRO-KPL400A1	400			
	PB-AXISPRO-KPL450A1	450			
	PB-AXISPRO-KPL500A1	500			
	PB-AXISPRO-KPL550A1	550			
	PB-AXISPRO-KPL600A1	600			
	PB-AXISPRO-KPL250A	250	antracyt anthracite	lakier lacquer	stal steel
	PB-AXISPRO-KPL300A	300			
	PB-AXISPRO-KPL350A	350			
	PB-AXISPRO-KPL400A	400			
	PB-AXISPRO-KPL450A	450			
	PB-AXISPRO-KPL500A	500			
	PB-AXISPRO-KPL550A	550			
	PB-AXISPRO-KPL600A	600			
	PB-AXISPRO-KPL250A2	250	czarny black	lakier lacquer	stal steel
	PB-AXISPRO-KPL300A2	300			
	PB-AXISPRO-KPL350A2	350			
	PB-AXISPRO-KPL400A2	400			
	PB-AXISPRO-KPL450A2	450			
	PB-AXISPRO-KPL500A2	500			
	PB-AXISPRO-KPL550A2	550			
	PB-AXISPRO-KPL600A2	600			

AXIS PRO soft close Komplet szuflady średniej "B" / AXIS PRO soft close Medium drawer set "B"

	 L mm			
PB-AXISPRO-KPL250B1	250	biały white	lakier lacquer	stal steel
PB-AXISPRO-KPL300B1	300			
PB-AXISPRO-KPL350B1	350			
PB-AXISPRO-KPL400B1	400			
PB-AXISPRO-KPL450B1	450			
PB-AXISPRO-KPL500B1	500			
PB-AXISPRO-KPL550B1	550			
PB-AXISPRO-KPL600B1	600			
PB-AXISPRO-KPL250B	250	antracyt anthracite	lakier lacquer	stal steel
PB-AXISPRO-KPL300B	300			
PB-AXISPRO-KPL350B	350			
PB-AXISPRO-KPL400B	400			
PB-AXISPRO-KPL450B	450			
PB-AXISPRO-KPL500B	500			
PB-AXISPRO-KPL550B	550			
PB-AXISPRO-KPL600B	600			





AXIS PRO soft close Komplet szuflady wysokiej "C" / AXIS PRO soft close High drawer set "C"

	 L mm			
PB-AXISPRO-KPL250C1	250	biały white	lakier lacquer	stal steel
PB-AXISPRO-KPL300C1	300			
PB-AXISPRO-KPL350C1	350			
PB-AXISPRO-KPL400C1	400			
PB-AXISPRO-KPL450C1	450			
PB-AXISPRO-KPL500C1	500			
PB-AXISPRO-KPL550C1	550			
PB-AXISPRO-KPL600C1	600			
PB-AXISPRO-KPL250C	250	antracyt anthracite	lakier lacquer	stal steel
PB-AXISPRO-KPL300C	300			
PB-AXISPRO-KPL350C	350			
PB-AXISPRO-KPL400C	400			
PB-AXISPRO-KPL450C	450			
PB-AXISPRO-KPL500C	500			
PB-AXISPRO-KPL550C	550			
PB-AXISPRO-KPL600C	600			
PB-AXISPRO-KPL250C2	250	czarny black	lakier lacquer	stal steel
PB-AXISPRO-KPL300C2	300			
PB-AXISPRO-KPL350C2	350			
PB-AXISPRO-KPL400C2	400			
PB-AXISPRO-KPL450C2	450			
PB-AXISPRO-KPL500C2	500			
PB-AXISPRO-KPL550C2	550			
PB-AXISPRO-KPL600C2	600			



AXIS PRO soft close Komplet szuflady bardzo wysokiej "D"/ *AXIS PRO soft close Extra high drawer set "D"*

	PB-AXISPRO-KPL250D1	250	biały white	lakier lacquer	stal steel
	PB-AXISPRO-KPL300D1	300			
	PB-AXISPRO-KPL350D1	350			
	PB-AXISPRO-KPL400D1	400			
	PB-AXISPRO-KPL450D1	450			
	PB-AXISPRO-KPL500D1	500			
	PB-AXISPRO-KPL550D1	550			
	PB-AXISPRO-KPL600D1	600			
	PB-AXISPRO-KPL250D	250	antracyt anthracite	lakier lacquer	stal steel
	PB-AXISPRO-KPL300D	300			
	PB-AXISPRO-KPL350D	350			
	PB-AXISPRO-KPL400D	400			
	PB-AXISPRO-KPL450D	450			
	PB-AXISPRO-KPL500D	500			
	PB-AXISPRO-KPL550D	550			
	PB-AXISPRO-KPL600D	600			
	PB-AXISPRO-KPL250D2	250	czarny black	lakier lacquer	stal steel
	PB-AXISPRO-KPL300D2	300			
	PB-AXISPRO-KPL350D2	350			
	PB-AXISPRO-KPL400D2	400			
	PB-AXISPRO-KPL450D2	450			
	PB-AXISPRO-KPL500D2	500			
	PB-AXISPRO-KPL550D2	550			
	PB-AXISPRO-KPL600D2	600			

Akcesoria do systemu szuflad AXIS PRO soft close/ *Accessories for the AXIS PRO soft close drawer system***Złączka frontu wewnętrznego niskiego / Inner front connector low**



	PB-AXISPRO-WEWMOCA1	biały white
	PB-AXISPRO-WEWMOCA	antracyt anthracite
	PB-AXISPRO-WEWMOCA2	czarny black
		stal steel

Złączka frontu wewnętrznego średniego / Inner front connector medium

	PB-AXISPRO-WEWMOCB1	biały white
	PB-AXISPRO-WEWMOCB	antracyt anthracite
		stal steel

Złączka frontu wewnętrznego wysoka / Inner front connector high



		
PB-AXISPRO-WEWMOCC1	biały white	stal steel
PB-AXISPRO-WEWMOCC	antracyt anthracite	
PB-AXISPRO-WEWMOCC2	czarny black	





Złączka frontu wewnętrznego bardzo wysoka / Inner front connector very high



		
PB-AXISPRO-WEWMOCD1	biały white	stal steel
PB-AXISPRO-WEWMOCD	antracyt anthracite	
PB-AXISPRO-WEWMOCD2	czarny black	





Zestaw do szuflady wewnętrznej niskiej / Set for low inside drawer



	 mm		
PB-AXISPRO-ZESWEW-A1	1200	biały white	stal steel
PB-AXISPRO-ZESWEW-A		antracyt anthracite	
PB-AXISPRO-ZESWEW-A2		czarny black	





Zestaw do szuflady wewnętrznej średniej / Set for medium inside drawer



	 mm		
PB-AXISPRO-ZESWEW-B1	1200	biały white	stal steel
PB-AXISPRO-ZESWEW-B		antracyt anthracite	





Zestaw do szuflady wewnętrznej wysokiej / Set for high inside drawer



	 mm		
PB-AXISPRO-ZESWEW-C1	1200	biały white	stal steel
PB-AXISPRO-ZESWEW-C		antracyt anthracite	
PB-AXISPRO-ZESWEW-C2		czarny black	

Zestaw do szuflady wewnętrznej bardzo wysokiej / Set for very high inside drawer





	 mm		
PB-AXISPRO-ZESWEW-D1	1200	biały white	stal steel
PB-AXISPRO-ZESWEW-D		antracyt anthracite	
PB-AXISPRO-ZESWEW-D2		czarny black	

Reling wzdłużny kwadratowy / Square longitudinal railing

	 mm	
PB-AXISPRO-RELKW250-10	250	biały white
PB-AXISPRO-RELKW300-10	300	
PB-AXISPRO-RELKW350-10	350	
PB-AXISPRO-RELKW400-10	400	
PB-AXISPRO-RELKW450-10	450	
PB-AXISPRO-RELKW500-10	500	
PB-AXISPRO-RELKW550-10	550	
PB-AXISPRO-RELKW600-10	600	
PB-AXISPRO-RELKW250	250	antracyt anthracite
PB-AXISPRO-RELKW300	300	
PB-AXISPRO-RELKW350	350	
PB-AXISPRO-RELKW400	400	
PB-AXISPRO-RELKW450	450	
PB-AXISPRO-RELKW500	500	
PB-AXISPRO-RELKW550	550	
PB-AXISPRO-RELKW600	600	
PB-AXISPRO-RELKW250-2	250	czarny black
PB-AXISPRO-RELKW300-2	300	
PB-AXISPRO-RELKW350-2	350	
PB-AXISPRO-RELKW400-2	400	
PB-AXISPRO-RELKW450-2	450	
PB-AXISPRO-RELKW500-2	500	
PB-AXISPRO-RELKW550-2	550	
PB-AXISPRO-RELKW600-2	600	

**Znacznik do mocowania frontów AXIS PRO**

/ Marker for fixing AXIS PRO front panels





	
PB-AXISPRO-RELKW250-10	tworzywo plastic



AXIS PRO soft close ze szklanymi bokami Komplet szuflady niskiej "A"

/ *AXIS PRO soft close with glass sides Low drawer set "A"*







				
PB-AXISPRO-GLASS-KPL300A1	300	biały <i>white</i>	lakier <i>lacquer</i>	stal <i>steel</i>
PB-AXISPRO-GLASS-KPL350A1	350			
PB-AXISPRO-GLASS-KPL400A1	400			
PB-AXISPRO-GLASS-KPL450A1	450			
PB-AXISPRO-GLASS-KPL500A1	500			
PB-AXISPRO-GLASS-KPL550A1	550			
PB-AXISPRO-GLASS-KPL300A	300	antracyt <i>anthracite</i>	lakier <i>lacquer</i>	stal <i>steel</i>
PB-AXISPRO-GLASS-KPL350A	350			
PB-AXISPRO-GLASS-KPL400A	400			
PB-AXISPRO-GLASS-KPL450A	450			
PB-AXISPRO-GLASS-KPL500A	500			
PB-AXISPRO-GLASS-KPL550A	550			
PB-AXISPRO-GLASS-KPL300A2	300	czarny <i>black</i>	lakier <i>lacquer</i>	stal <i>steel</i>
PB-AXISPRO-GLASS-KPL350A2	350			
PB-AXISPRO-GLASS-KPL400A2	400			
PB-AXISPRO-GLASS-KPL450A2	450			
PB-AXISPRO-GLASS-KPL500A2	500			
PB-AXISPRO-GLASS-KPL550A2	550			





AXIS PRO soft close ze szklanymi bokami Komplet szuflady średniej "B"

/ *AXIS PRO soft close with glass sides Medium drawer set "B"*





				
PB-AXISPRO-GLASS-KPL300B1	300	biały <i>white</i>	lakier <i>lacquer</i>	stal <i>steel</i>
PB-AXISPRO-GLASS-KPL350B1	350			
PB-AXISPRO-GLASS-KPL400B1	400			
PB-AXISPRO-GLASS-KPL450B1	450			
PB-AXISPRO-GLASS-KPL500B1	500			
PB-AXISPRO-GLASS-KPL550B1	550			
PB-AXISPRO-GLASS-KPL300B	300	antracyt <i>anthracite</i>	lakier <i>lacquer</i>	stal <i>steel</i>
PB-AXISPRO-GLASS-KPL350B	350			
PB-AXISPRO-GLASS-KPL400B	400			
PB-AXISPRO-GLASS-KPL450B	450			
PB-AXISPRO-GLASS-KPL500B	500			
PB-AXISPRO-GLASS-KPL550B	550			



AXIS PRO soft close ze szklanymi bokami Komplet szuflady wysokiej "C"/ *AXIS PRO soft close with glass sides High drawer set "C"*

	 L mm			
PB-AXISPRO-GLASS-KPL300C1	300	biały white	lakier lacquer	stal steel
PB-AXISPRO-GLASS-KPL350C1	350			
PB-AXISPRO-GLASS-KPL400C1	400			
PB-AXISPRO-GLASS-KPL450C1	450			
PB-AXISPRO-GLASS-KPL500C1	500			
PB-AXISPRO-GLASS-KPL550C1	550			
PB-AXISPRO-GLASS-KPL300C	300	antracyt anthracite	lakier lacquer	stal steel
PB-AXISPRO-GLASS-KPL350C	350			
PB-AXISPRO-GLASS-KPL400C	400			
PB-AXISPRO-GLASS-KPL450C	450			
PB-AXISPRO-GLASS-KPL500C	500			
PB-AXISPRO-GLASS-KPL550C	550			
PB-AXISPRO-GLASS-KPL300C2	300	czarny black	lakier lacquer	stal steel
PB-AXISPRO-GLASS-KPL350C2	350			
PB-AXISPRO-GLASS-KPL400C2	400			
PB-AXISPRO-GLASS-KPL450C2	450			
PB-AXISPRO-GLASS-KPL500C2	500			
PB-AXISPRO-GLASS-KPL550C2	550			



Akcesoria do systemu szuflad AXIS PRO soft close ze szklanymi bokami/ *Accessories for the AXIS PRO soft close drawer system with glass sides***Szklany panel frontu wewnętrznego, niski** / *Glass panel for internal front, low*

		
PB-AXISPRO-GLASS-PAWEW-A1	biały white	stal steel
PB-AXISPRO-GLASS-PAWEW-A2	czarny black	

Szklany panel frontu wewnętrznego, średni / *Glass panel for internal front, medium*



		
PB-AXISPRO-GLASS-PAWEW-B1	biały white	stal steel
PB-AXISPRO-GLASS-PAWEW-B2	czarny black	

Szklany panel frontu wewnętrznego, wysoki / *Glass panel for internal front, high*

		
PB-AXISPRO-GLASS-PAWEW-C1	biały white	stal steel
PB-AXISPRO-GLASS-PAWEW-C2	czarny black	



Złączka frontu wewnętrznego niska / Inner front connector low



		
PB-AXISPRO-GLASS-WEWMOCA1	biały white	stal steel
PB-AXISPRO-GLASS-WEWMOCA	antracyt anthracite	
PB-AXISPRO-GLASS-WEWMOCA2	czarny black	



Złączka frontu wewnętrznego średnia / Inner front connector medium



		
PB-AXISPRO-GLASS-WEWMOCB1	biały white	stal steel
PB-AXISPRO-GLASS-WEWMOCB	antracyt anthracite	





Złączka frontu wewnętrznego wysoka / Inner front connector high



		
PB-AXISPRO-GLASS-WEWMOCC1	biały white	stal steel
PB-AXISPRO-GLASS-WEWMOCC	antracyt anthracite	
PB-AXISPRO-GLASS-WEWMOCC2	czarny black	





Zestaw do szuflady wewnętrznej niskiej / Set for low inside drawer







			
PB-AXISPRO-GLASS-ZEWEW-A1	1200	biały white	stal steel
PB-AXISPRO-GLASS-ZEWEW-A		antracyt anthracite	
PB-AXISPRO-GLASS-ZEWEW-A2		czarny black	

Zestaw do szuflady wewnętrznej średniej / Set for medium inside drawer







			
PB-AXISPRO-GLASS-ZEWEW-B1	1200	biały white	stal steel
PB-AXISPRO-GLASS-ZEWEW-B		antracyt anthracite	
PB-AXISPRO-GLASS-ZEWEW-B2		czarny black	





Zestaw do szuflady wewnętrznej wysokiej / Set for high inside drawer

	 L mm		
PB-AXISPRO-GLASS-ZEWEW-C1	1200	biały white	stal steel
PB-AXISPRO-GLASS-ZEWEW-C		antracyt anthracite	
PB-AXISPRO-GLASS-ZEWEW-C2		czarny black	

AXIS PRO push to open Komplet szuflady ekstra niskiej / AXIS PRO push to open Extra low drawer set

	 L mm			
PB-AXISPRO-P2O-KPL69-450-10	450	biały white	lakier lacquer	stal steel
PB-AXISPRO-P2O-K69-450-10	450			
PB-AXISPRO-P2O-KPL69-500-10	450			
PB-AXISPRO-P2O-K69-500-10	450			
PB-AXISPRO-P2O-KPL69-450-60	450	antracyt anthracite	lakier lacquer	stal steel
PB-AXISPRO-P2O-K69-450-60	450			
PB-AXISPRO-P2O-KPL69-500-60	450			
PB-AXISPRO-P2O-K69-500-60	450			

AXIS PRO push to open Komplet szuflady niskiej "A" / Low drawer set "A"

	 L mm			
PB-AXISPRO-P2O-KPL300A1	300	biały white	lakier lacquer	stal steel
PB-AXISPRO-P2O-KPL350A1	350			
PB-AXISPRO-P2O-KPL400A1	400			
PB-AXISPRO-P2O-KPL450A1	450			
PB-AXISPRO-P2O-KPL500A1	500			
PB-AXISPRO-P2O-KPL550A1	550			
PB-AXISPRO-P2O-KPL300A	300	antracyt anthracite	lakier lacquer	stal steel
PB-AXISPRO-P2O-KPL350A	350			
PB-AXISPRO-P2O-KPL400A	400			
PB-AXISPRO-P2O-KPL450A	450			
PB-AXISPRO-P2O-KPL500A	500			
PB-AXISPRO-P2O-KPL550A	550			
PB-AXISPRO-P2O-KPL300A2	300	czarny black	lakier lacquer	stal steel
PB-AXISPRO-P2O-KPL350A2	350			
PB-AXISPRO-P2O-KPL400A2	400			
PB-AXISPRO-P2O-KPL450A2	450			
PB-AXISPRO-P2O-KPL500A2	500			
PB-AXISPRO-P2O-KPL550A2	550			

Mocowanie poprzeczki synchronizującej do wersji push to open





/ Mounting for the synchronizing bar for the push to open version

PB-AXISPRO-SYN-P2O-MOC	-	szary, gray	-	-
------------------------	---	-------------	---	---

Poprzeczka synchronizująca do wersji push to open / Synchronizing bar for the push to open version

PB-AXISPRO-SYNCHRO-P2O	-	szary, gray	-	-
------------------------	---	-------------	---	---

AXIS PRO push to open Komplet szuflady średniej "B" / Medium drawer set "B"

	 L mm			
PB-AXISPRO-P2O-KPL300B1	300	biały white	lakier lacquer	stal steel
PB-AXISPRO-P2O-KPL350B1	350			
PB-AXISPRO-P2O-KPL400B1	400			
PB-AXISPRO-P2O-KPL450B1	450			
PB-AXISPRO-P2O-KPL500B1	500			
PB-AXISPRO-P2O-KPL550B1	550			
PB-AXISPRO-P2O-KPL300B	300	antracyt anthracite	lakier lacquer	stal steel
PB-AXISPRO-P2O-KPL350B	350			
PB-AXISPRO-P2O-KPL400B	400			
PB-AXISPRO-P2O-KPL450B	450			
PB-AXISPRO-P2O-KPL500B	500			
PB-AXISPRO-P2O-KPL550B	550			

Mocowanie poprzeczki synchronizującej do wersji push to open





/ Mounting for the synchronizing bar for the push to open version

PB-AXISPRO-SYN-P2O-MOC	-	szary, gray	-	-
------------------------	---	-------------	---	---

Poprzeczka synchronizująca do wersji push to open / Synchronizing bar for the push to open version

PB-AXISPRO-SYNCHRO-P2O	-	szary, gray	-	-
------------------------	---	-------------	---	---

AXIS PRO push to open Komplet szuflady wysokiej "C" / High drawer set "C"

	 L mm			
PB-AXISPRO-P2O-KPL300C1	300	biały white	lakier lacquer	stal steel
PB-AXISPRO-P2O-KPL350C1	350			
PB-AXISPRO-P2O-KPL400C1	400			
PB-AXISPRO-P2O-KPL450C1	450			
PB-AXISPRO-P2O-KPL500C1	500			
PB-AXISPRO-P2O-KPL550C1	550			
PB-AXISPRO-P2O-KPL300C	300	antracyt anthracite	lakier lacquer	stal steel
PB-AXISPRO-P2O-KPL350C	350			
PB-AXISPRO-P2O-KPL400C	400			
PB-AXISPRO-P2O-KPL450C	450			
PB-AXISPRO-P2O-KPL500C	500			
PB-AXISPRO-P2O-KPL550C	550			
PB-AXISPRO-P2O-KPL300C2	300	czarny black	lakier lacquer	stal steel
PB-AXISPRO-P2O-KPL350C2	350			
PB-AXISPRO-P2O-KPL400C2	400			
PB-AXISPRO-P2O-KPL450C2	450			
PB-AXISPRO-P2O-KPL500C2	500			
PB-AXISPRO-P2O-KPL550C2	550			

Mocowanie poprzeczki synchronizującej do wersji push to open

/ Mounting for the synchronizing bar for the push to open version





PB-AXISPRO-SYN-P2O-MOC	-	szary, gray	-	-
------------------------	---	-------------	---	---

Poprzeczka synchronizująca do wersji push to open / Synchronizing bar for the push to open version

PB-AXISPRO-SYNCHRO-P2O	-	szary, gray	-	-
------------------------	---	-------------	---	---



AXIS PRO push to open Komplet szuflady bardzo wysokiej "D" / Very high drawer set "D"

	 mm			
PB-AXISPRO-P2O-KPL300D1	300	biały white	lakier lacquer	stal steel
PB-AXISPRO-P2O-KPL350D1	350			
PB-AXISPRO-P2O-KPL400D1	400			
PB-AXISPRO-P2O-KPL450D1	450			
PB-AXISPRO-P2O-KPL500D1	500			
PB-AXISPRO-P2O-KPL550D1	550			
PB-AXISPRO-P2O-KPL300D	300	antracyt anthracite	lakier lacquer	stal steel
PB-AXISPRO-P2O-KPL350D	350			
PB-AXISPRO-P2O-KPL400D	400			
PB-AXISPRO-P2O-KPL450D	450			
PB-AXISPRO-P2O-KPL500D	500			
PB-AXISPRO-P2O-KPL550D	550			
PB-AXISPRO-P2O-KPL300D2	300	czarny black	lakier lacquer	stal steel
PB-AXISPRO-P2O-KPL350D2	350			
PB-AXISPRO-P2O-KPL400D2	400			
PB-AXISPRO-P2O-KPL450D2	450			
PB-AXISPRO-P2O-KPL500D2	500			
PB-AXISPRO-P2O-KPL550D2	550			

Mocowanie poprzeczki synchronizującej do wersji push to open

/ Mounting for the synchronizing bar for the push to open version

PB-AXISPRO-SYN-P2O-MOC	-	szary, gray	-	-
------------------------	---	-------------	---	---



Poprzeczka synchronizująca do wersji push to open / Synchronizing bar for the push to open version

PB-AXISPRO-SYNCHRO-P2O	-	szary, gray	-	-
------------------------	---	-------------	---	---



Akcesoria do systemu szuflad AXIS PRO push to open

/ Accessories for the AXIS PRO push to open drawer system

Złączka frontu wewnętrznego niska / Inner front connector low

		
PB-AXISPRO-WEWMOCA1	biały white	stal steel
PB-AXISPRO-WEWMOCA	antracyt anthracite	
PB-AXISPRO-WEWMOCA2	czarny black	

Złączka frontu wewnętrznego średnia / Inner front connector medium

		
PB-AXISPRO-WEWMOCB1	biały white	stal steel
PB-AXISPRO-WEWMOCB	antracyt anthracite	

Złączka frontu wewnętrznego wysoka / Inner front connector high



PB-AXISPRO-WEWMOCC1	biały white	stal steel
PB-AXISPRO-WEWMOCC	antracyt anthracite	
PB-AXISPRO-WEWMOCC2	czarny black	

Złączka frontu wewnętrznego bardzo wysoka / Inner front connector very high



PB-AXISPRO-WEWMOCD1	biały white	stal steel
PB-AXISPRO-WEWMOCD	antracyt anthracite	
PB-AXISPRO-WEWMOCD2	czarny black	

Zestaw do szuflady wewnętrznej niskiej / Set for low inside drawer



PB-AXISPRO-ZESWEW-A1	1200	biały white	stal steel
PB-AXISPRO-ZESWEW-A		antracyt anthracite	
PB-AXISPRO-ZESWEW-A2		czarny black	

Zestaw do szuflady wewnętrznej średniej / Set for medium inside drawer



PB-AXISPRO-ZESWEW-B1	1200	biały white	stal steel
PB-AXISPRO-ZESWEW-B		antracyt anthracite	

Zestaw do szuflady wewnętrznej wysokiej / Set for high inside drawer



PB-AXISPRO-ZESWEW-C1	1200	biały white	stal steel
PB-AXISPRO-ZESWEW-C		antracyt anthracite	
PB-AXISPRO-ZESWEW-C2		czarny black	

Zestaw do szuflady wewnętrznej bardzo wysokiej / Set for very high inside drawer





PB-AXISPRO-ZESWEW-D1	1200	biały white	stal steel
PB-AXISPRO-ZESWEW-D		antracyt anthracite	
PB-AXISPRO-ZESWEW-D2		czarny black	

Reling wzdłużny kwadratowy / Square longitudinal railing

	 mm	
PB-AXISPRO-RELKW250-10	250	biały white
PB-AXISPRO-RELKW300-10	300	
PB-AXISPRO-RELKW350-10	350	
PB-AXISPRO-RELKW400-10	400	
PB-AXISPRO-RELKW450-10	450	
PB-AXISPRO-RELKW500-10	500	
PB-AXISPRO-RELKW550-10	550	
PB-AXISPRO-RELKW600-10	600	
PB-AXISPRO-RELKW250	250	antracyt anthracite
PB-AXISPRO-RELKW300	300	
PB-AXISPRO-RELKW350	350	
PB-AXISPRO-RELKW400	400	
PB-AXISPRO-RELKW450	450	
PB-AXISPRO-RELKW500	500	
PB-AXISPRO-RELKW550	550	
PB-AXISPRO-RELKW600	600	
PB-AXISPRO-RELKW250-2	250	czarny black
PB-AXISPRO-RELKW300-2	300	
PB-AXISPRO-RELKW350-2	350	
PB-AXISPRO-RELKW400-2	400	
PB-AXISPRO-RELKW450-2	450	
PB-AXISPRO-RELKW500-2	500	
PB-AXISPRO-RELKW550-2	550	
PB-AXISPRO-RELKW600-2	600	

**Znacznik do mocowania frontów AXIS PRO**









/ Marker for fixing AXIS PRO front panels

	
PB-AXISPRO-RELKW250-10	tworzywo plastic











MODERN BOX PRO / MODERN BOX PRO

MODERN BOX PRO Komplet szuflady niskiej "A" / MODERN BOX PRO Low drawer set "A"

					
	PB-MBPRO-KPL300A1	300	biały <i>white</i>	lakier <i>lacquer</i>	stal <i>steel</i>
	PB-MBPRO-KPL350A1	350			
	PB-MBPRO-KPL400A1	400			
	PB-MBPRO-KPL450A1	450			
	PB-MBPRO-KPL500A1	500			
	PB-MBPRO-KPL550A1	550			
	PB-MBPRO-KPL300A-30	300	szary <i>gray</i>	lakier <i>lacquer</i>	stal <i>steel</i>
	PB-MBPRO-KPL350A-30	350			
	PB-MBPRO-KPL400A-30	400			
	PB-MBPRO-KPL450A-30	450			
	PB-MBPRO-KPL500A-30	500			
	PB-MBPRO-KPL550A-30	550			
	PB-MBPRO-KPL300A	300	antracyt <i>anthracite</i>	lakier <i>lacquer</i>	stal <i>steel</i>
	PB-MBPRO-KPL350A	350			
	PB-MBPRO-KPL400A	400			
	PB-MBPRO-KPL450A	450			
	PB-MBPRO-KPL500A	500			
	PB-MBPRO-KPL550A	550			

MODERN BOX PRO Komplet szuflady średniej "B" / MODERN BOX PRO Medium drawer set "B"

					
	PB-MBPRO-KPL300B1	300	biały <i>white</i>	lakier <i>lacquer</i>	stal <i>steel</i>
	PB-MBPRO-KPL350B1	350			
	PB-MBPRO-KPL400B1	400			
	PB-MBPRO-KPL450B1	450			
	PB-MBPRO-KPL500B1	500			
	PB-MBPRO-KPL550B1	550			
	PB-MBPRO-KPL300B-30	300	szary <i>gray</i>	lakier <i>lacquer</i>	stal <i>steel</i>
	PB-MBPRO-KPL350B-30	350			
	PB-MBPRO-KPL400B-30	400			
	PB-MBPRO-KPL450B-30	450			
	PB-MBPRO-KPL500B-30	500			
	PB-MBPRO-KPL550B-30	550			
	PB-MBPRO-KPL300B	300	antracyt <i>anthracite</i>	lakier <i>lacquer</i>	stal <i>steel</i>
	PB-MBPRO-KPL350B	350			
	PB-MBPRO-KPL400B	400			
	PB-MBPRO-KPL450B	450			
	PB-MBPRO-KPL500B	500			
	PB-MBPRO-KPL550B	550			

MODERN BOX PRO Komplet szuflady wysokiej "C" / MODERN BOX PRO High drawer set "C"

PB-MBPRO-KPL300C1	300	biały white	lakier lacquer	stal steel
PB-MBPRO-KPL350C1	350			
PB-MBPRO-KPL400C1	400			
PB-MBPRO-KPL450C1	450			
PB-MBPRO-KPL500C1	500			
PB-MBPRO-KPL550C1	550			
PB-MBPRO-KPL300C-30	300	szary gray	lakier lacquer	stal steel
PB-MBPRO-KPL350C-30	350			
PB-MBPRO-KPL400C-30	400			
PB-MBPRO-KPL450C-30	450			
PB-MBPRO-KPL500C-30	500			
PB-MBPRO-KPL550C-30	550			
PB-MBPRO-KPL300C	300	antracyt anthracite	lakier lacquer	stal steel
PB-MBPRO-KPL350C	350			
PB-MBPRO-KPL400C	400			
PB-MBPRO-KPL450C	450			
PB-MBPRO-KPL500C	500			
PB-MBPRO-KPL550C	550			

MODERN BOX PRO Opcja "D" / MODERN BOX PRO Option "D"

Komplet szuflady niskiej A / Low drawer set A	Reling wzdużny / Longitudinal drawer rail				
PB-MBPRO-KPL300A1	PB-MBPRO-RELKW300-10	300	biały white	lakier lacquer	stal steel
PB-MBPRO-KPL350A1	PB-MBPRO-RELKW350-10	350			
PB-MBPRO-KPL400A1	PB-MBPRO-RELKW400-10	400			
PB-MBPRO-KPL450A1	PB-MBPRO-RELKW450-10	450			
PB-MBPRO-KPL500A1	PB-MBPRO-RELKW500-10	500			
PB-MBPRO-KPL550A1	PB-MBPRO-RELKW550-10	550			
PB-MBPRO-KPL300A-30	PB-MBPRO-RELKW300-30	300	szary gray	lakier lacquer	stal steel
PB-MBPRO-KPL350A-30	PB-MBPRO-RELKW350-30	350			
PB-MBPRO-KPL400A-30	PB-MBPRO-RELKW400-30	400			
PB-MBPRO-KPL450A-30	PB-MBPRO-RELKW450-30	450			
PB-MBPRO-KPL500A-30	PB-MBPRO-RELKW500-30	500			
PB-MBPRO-KPL550A-30	PB-MBPRO-RELKW550-30	550			
PB-MBPRO-KPL300A	PB-MBPRO-RELKW300	300	antracyt anthracite	lakier lacquer	stal steel
PB-MBPRO-KPL350A	PB-MBPRO-RELKW350	350			
PB-MBPRO-KPL400A	PB-MBPRO-RELKW400	400			
PB-MBPRO-KPL450A	PB-MBPRO-RELKW450	450			
PB-MBPRO-KPL500A	PB-MBPRO-RELKW500	500			
PB-MBPRO-KPL550A	PB-MBPRO-RELKW550	550			

Reling wzdluzny / Longitudinal drawer railing



	 L mm	
PB-MBPRO-RELKW300-10	300	biały white
PB-MBPRO-RELKW350-10	350	
PB-MBPRO-RELKW400-10	400	
PB-MBPRO-RELKW450-10	450	
PB-MBPRO-RELKW500-10	500	
PB-MBPRO-RELKW550-10	550	
PB-MBPRO-RELKW300-30	300	szary gray
PB-MBPRO-RELKW350-30	350	
PB-MBPRO-RELKW400-30	400	
PB-MBPRO-RELKW450-30	450	
PB-MBPRO-RELKW500-30	500	
PB-MBPRO-RELKW550-30	550	
PB-MBPRO-RELKW300	300	antracyt anthracite
PB-MBPRO-RELKW350	350	
PB-MBPRO-RELKW400	400	
PB-MBPRO-RELKW450	450	
PB-MBPRO-RELKW500	500	
PB-MBPRO-RELKW550	550	

Złączka frontu wewnętrznego niska / Inner front connector low



		
PB-MBPRO-WEWMOCA1	biały white	stal steel
PB-MBPRO-WEWMOCA-30	szary gray	
PB-MBPRO-WEWMOCA	antracyt anthracite	

Złączka frontu wewnętrznego średnia / Inner front connector medium



		
PB-MBPRO-WEWMOCB1	biały white	stal steel
PB-MBPRO-WEWMOCB-30	szary gray	
PB-MBPRO-WEWMOCB	antracyt anthracite	

Złączka frontu wewnętrznego wysoka / Inner front connector high



		
PB-MBPRO-WEWMOCC1	biały white	stal steel
PB-MBPRO-WEWMOCC-30	szary gray	
PB-MBPRO-WEWMOCC	antracyt anthracite	

Złączka frontu „D” / Front connector „D”

PB-MBPRO-WEWMOCD1	biały white	stal steel
PB-MBPRO-WEWMOCD-30	szary gray	
PB-MBPRO-WEWMOCD	antracyt anthracite	

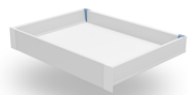
Złączka ścianki tylnej, niska / Back panel connector, low

PB-MBPRO-ZLATYLA1	biały white	stal steel
PB-MBPRO-ZLATYLA-30	szary gray	
PB-MBPRO-ZLATYLA	antracyt anthracite	

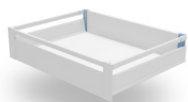
Złączka ścianki tylnej, średnia / Back panel connector, medium

PB-MBPRO-ZLATYLB1	biały white	stal steel
PB-MBPRO-ZLATYLB-30	szary gray	
PB-MBPRO-ZLATYLB	antracyt anthracite	

Złączka ścianki tylnej, wysoka / Back panel connector, high

PB-MBPRO-ZLATYLC1	biały white	stal steel
PB-MBPRO-ZLATYLC-30	szary gray	
PB-MBPRO-ZLATYLC	antracyt anthracite	

Złączka ścianki tylnej „D” / Back panel connector „D”

PB-MBPRO-ZLATYLD1	biały white	stal steel
PB-MBPRO-ZLATYLD-30	szary gray	
PB-MBPRO-ZLATYLD	antracyt anthracite	

Mocowanie relingu do podwyższonej ścianki tylnej

/ Back panel connector for rails, additional



PB-MBPRO-MOCRELYL1	biały white	tworzywo plastic
PB-MBPRO-MOCRELYL-30	szary gray	
PB-MBPRO-MOCRELYL	antracyt anthracite	

Zestaw do szuflady wewnętrznej niskiej / Set for low inner drawer



PB-MBPRO-ZESWEW-A1	biały white	tworzywo plastic
PB-MBPRO-ZESWEW-A-30	szary gray	
PB-MBPRO-ZESWEW-A	antracyt anthracite	

Zestaw do szuflady wewnętrznej średniej / Set for medium inner drawer



PB-MBPRO-ZESWEW-B1	biały white	tworzywo plastic
PB-MBPRO-ZESWEW-B-30	szary gray	
PB-MBPRO-ZESWEW-B	antracyt anthracite	

Zestaw do szuflady wewnętrznej wysokiej / Set for high inner drawer



PB-MBPRO-ZESWEW-C1	biały white	tworzywo plastic
PB-MBPRO-ZESWEW-C-30	szary gray	
PB-MBPRO-ZESWEW-C	antracyt anthracite	

Zestaw do szuflady wewnętrznej „D” / Set for „D” inner drawer



PB-MBPRO-ZESWEW-D1	biały white	stal steel
PB-MBPRO-ZESWEW-D-30	szary gray	
PB-MBPRO-ZESWEW-D	antracyt anthracite	

Szablon do szuflad AXIS PRO i MODERN BOX

/ Template for AXIS PRO and MODERN BOX drawers



PB-SZABLON-AXIS-MBPRO	stal steel







Prowadnice / Slides

MODERN SLIDE PRO / MODERN SLIDE PRO

Prowadnica dolnego montażu MODERN SLIDE PRO

/ Undermount drawer slide MODERN SLIDE PRO









	 L mm	 AV mm	Wysuw Extension	 kg l		
PB-3D0SHX18-300-PRO	300	30	pełny full	35	ocynk galvanized	stal steel
PB-3D0SHX18-350-PRO	350	30		36		
PB-3D0SHX18-400-PRO	400	30		37		
PB-3D0SHX18-450-PRO	450	30		38		
PB-3D0SHX18-500-PRO	500	30		39		
PB-3D0SHX18-550-PRO	550	30		40		

Prowadnica dolnego montażu MODERN SLIDE PRO push to open

/ Undermount drawer slide MODERN SLIDE PRO push to open



	 L mm	 AV mm	Wysuw Extension	 kg l		
PB-3D0FPO18-250-PRO	250	5	pełny full	35	ocynk galvanized	stal steel
PB-3D0FPO18-300-PRO	300	5		35		
PB-3D0FPO18-350-PRO	350	5		35		
PB-3D0FPO18-400-PRO	400	5		35		
PB-3D0FPO18-450-PRO	450	5		35		
PB-3D0FPO18-500-PRO	500	5		35		
PB-3D0FPO18-550-PRO	550	5		35		
PB-3D0FPO18-600-PRO	600	5		35		

Synchronization / Crossbar



PB-SYNCHROP20-PRO	1100	-	-	-	ocynk galvanized	stal steel
-------------------	------	---	---	---	---------------------	---------------

Mocowanie poprzeczki synchronizującej / Synchronizing crossbar mount









PB-SYNCHROP20-PRO-MOC	-	-	-	-	-	tworzywo plastic
-----------------------	---	---	---	---	---	---------------------

Prowadnica dolnego montażu MODERN SLIDE PRO soft move

/ Undermount drawer slide MODERN SLIDE PRO soft move



	 L mm	 AV mm	Wysuw Extension	 kg l		
PB-2IN1-3D0SHX18-450-PRO	450	-	pełny full	35	ocynk galvanized	stal steel
PB-2IN1-3D0SHX18-500-PRO	500	-		35		

**Zintegrowany mechanizm push to open i soft close do prowadnicy
MODERN SLIDE PRO soft move**

/ Integrated push to open and soft close mechanism for MODERN SLIDE PRO soft move



			Wysuw Extension			
PB-2IN1-MOTION	-	-	-	-	-	tworzywo plastic

Poprzeczka do montażu mechanizmu 2in1 / Mounting bar for 2in1 mechanism



		Wysuw Extension			
PB-2IN1-SYNCHROPRO-520-600	520-600	-	-	ocynk galvanized	stal steel
PB-2IN1-SYNCHROPRO-600-820	600-820	-	-		
PB-2IN1-SYNCHROPRO-820-1000	820-1000	-	-		

3D0SHX / 3D0SHX

Prowadnica dolnego montażu ze spowalniczem 3D0SHX

/ Undermount drawer slide with soft closing 3D0SHX



			Wysuw Extension			
PB-3D0SHX18-250-H	250	16	pełny full	35	ocynk galvanized	stal steel
PB-3D0SHX18-300-H	300	16		35		
PB-3D0SHX18-350-H	350	16		35		
PB-3D0SHX18-400-H	400	16		35		
PB-3D0SHX18-450-H	450	16		35		
PB-3D0SHX18-500-H	500	16		35		
PB-3D0SHX18-550-H	550	16		35		
PB-3D0SHX18-600-H	600	16		35		





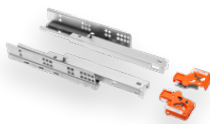

OFPO / OFPO

Prowadnica push to open OFPO / Slide push to open OFPO



			Wysuw Extension			
PB-0FPO18-250	250	26	pełny full	25	ocynk galvanized	stal steel
PB-0FPO18-300	300	26		25		
PB-0FPO18-350	350	26		25		
PB-0FPO18-400	400	26		25		
PB-0FPO18-450	450	26		25		
PB-0FPO18-500	500	26		25		
PB-0FPO18-550	550	26		25		
PB-0FPO18-600	600	26		25		

GCHX18-H / GCHX18-H**Prowadnica dolnego montażu ze spowalniczem GCHX18-H***/ Undermount drawer slide with soft closing GCHX18-H*

			Wysuw Extension			
PB-GCHX18-300-H	300	88,5	niepełny partial	25	ocynk galvanized	stal steel
PB-GCHX18-350-H	350	88,5		26		
PB-GCHX18-400-H	400	118,5		27		
PB-GCHX18-450-H	450	118,5		28		
PB-GCHX18-500-H	500	118,5		29		
PB-GCHX18-550-H	550	118,5		30		

Wspornik szuflad cokołowych MORE SPACE / Plinth drawer support MORE SPACE

		
PB-WSPCOK	ocynk galvanized	stal steel



Akcesoria do szuflad / Drawer accessories**WKŁADY CUSTOMI / CUSTOMI INSERTS****Wkład CUSTOMI regulowany / Adjustable cutlery organizer CUSTOMI**

				
W-CUSTOMI-60L450	424 × 305	lakier bezbardwy matowy clearcoat matt surface	buk beech	drewno buk beech wood
W-CUSTOMI-60L500	474 × 305	lakier bezbardwy matowy clearcoat matt surface	buk beech	drewno buk beech wood
W-CUSTOMI-80L450	512 × 424	lakier bezbardwy matowy clearcoat matt surface	buk beech	drewno buk beech wood
W-CUSTOMI-80L500	512 × 474	lakier bezbardwy matowy clearcoat matt surface	buk beech	drewno buk beech wood

WKŁADY AXISPACE / AXISPACE INSERTS

Wkład do szuflad Axispace / Cutlery organizer Axispace



		
WK-SZ-AS-400-10	biały white	tworzywo plastic
WK-SZ-AS-500-10		
WK-SZ-AS-600-10		
WK-SZ-AS-700-10		
WK-SZ-AS-800-10		
WK-SZ-AS-900-10		
WK-SZ-AS-400-60	antracyt anthracite	tworzywo plastic
WK-SZ-AS-500-60		
WK-SZ-AS-600-60		
WK-SZ-AS-700-60		
WK-SZ-AS-800-60		
WK-SZ-AS-900-60		
WK-SZ-AS-400-20	czarny black	tworzywo plastic
WK-SZ-AS-500-20		
WK-SZ-AS-600-20		
WK-SZ-AS-700-20		
WK-SZ-AS-800-20		
WK-SZ-AS-900-20		

MATY AXISPACE / AXISPACE MATS

Mata antypoślizgowa AXISPACE do szuflad / Anti-slip mat for drawers AXISPACE

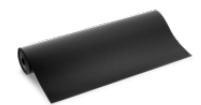





		
MA-MATA-1-10	5000×480	biały white
MA-MATA-1-60	5000×480	szary gray
MA-MATA-1-20	5000×480	czarny black

SEGREGATORY AXISPACE / TRASH BINS AXISPACE

Segregator AXISPACE / Trash bin AXISPACE



				
PB-AS-600-1X15L-2X7L-45	600	1 × 15 l 2 × 7 l	antracyt anthracite	tworzywo sztuczne z cząsteczkami grafenu* plastic with graphene particles*
PB-AS-600-1X15L-3X7L		1 × 15 l 2 × 7 l		
PB-AS-600-2X15L-2X7L		2 × 15 l 2 × 7 l		
PB-AS-600-2X15L-45		2 × 15 l		
PB-AS-700-2X15L-2X7L-45	700	2 × 15 l 2 × 7 l		
PB-AS-800-4X15L	800	4 × 15 l		
PB-AS-800-2X15L-2X7L-45		2 × 15 l 2 × 7 l		
PB-AS-900-4X15L	900	4 × 15 l		
PB-AS-W-15L	-	1 × 15 l		
PB-AS-W-7L	-	1 × 7 l		





*Grafen to nanomateriał utworzony z węgla o działaniu antybakteryjnym i antygrzybicznym. Jest on w stanie wyeliminować ze swojej powierzchni nawet do 99% drobnoustrojów w przeciągu 120 minut.

*Graphene is a nanomaterial made of carbon with antibacterial and antifungal properties. It is able to eliminate up to 99% of microorganisms from its surface within 120 minute.

SEGREGATORY PRACTI ECO / TRASH BINS PRACTI ECO

Segregator PRACTI ECO 300 / Trash bin PRACTI ECO 300







				
PB-45-0010X3-60A	300	3 × 10 l	antracyt anthracite	tworzywo plastic
PB-45-002010-60A	300	1 × 10 l 1 × 20 l	antracyt anthracite	tworzywo plastic

na prowadnicy kulkowej H45 z cichym domykiem / on H45 ball bearing slide with soft close

Segregator PRACTI ECO 400 / Trash bin PRACTI ECO 400







				
PB-45-400MF-2X16-60A	400	2 × 16 l	antracyt anthracite	tworzywo plastic
PB-45-002X20-60A	400	2 × 20 l	antracyt anthracite	tworzywo plastic

Segregator PRACTI ECO 400 z mocowaniem przednim

/ Trash bin PRACTI ECO 400 with door mount bracket



				
PB-45-MF002X20-60A	400	2 × 20 l	antracyt anthracite	tworzywo plastic





na prowadnicy z cichym domykiem / on slide with soft close



PB-45-MF202X10-60A	400	1 × 20 l 2 × 10 l	antracyt anthracite	tworzywo plastic
--------------------	-----	----------------------	------------------------	---------------------

Segregator PRACTI ECO 450, niski / Trash bin PRACTI ECO 450, low







				
PB-45-002X15-60A	450	2 × 15 l	antracyt anthracite	tworzywo plastic

na prowadnicy z cichym domykiem / on slide with soft close

Segregator PRACTI ECO 450, niski z mocowaniem przednim

/ Trash bin PRACTI ECO 450 low with door mount bracket





				
PB-45-MF2X15-60A	450	2 × 15 l	antracyt anthracite	tworzywo plastic

na prowadnicy z cichym domykiem / on slide with soft close

Segregator PRACTI ECO 450 wysoki / Trash bin PRACTI ECO 450 high



				
PB-45-450-2X20-60A	450	2 × 20 l	antracyt anthracite	tworzywo plastic

na prowadnicy z cichym domykiem / on slide with soft close



PB-45-202X10-60A	450	1 × 20 l 2 × 10 l	antracyt anthracite	tworzywo plastic
------------------	-----	----------------------	------------------------	---------------------

Segregator PRACTI ECO 450 wysoki z mocowaniem przednim*/ Trash bin PRACTI ECO 450 high with door mount bracket*

				
PB-45-450MF202X10-60A	450	1 × 20 l 2 × 10 l	antracyt anthracite	tworzywo plastic

na prowadnicy z cichym domykiem / on slide with soft close



PB-45-MF2X20-60A	450	2 × 20 l	antracyt anthracite	tworzywo plastic
------------------	-----	----------	------------------------	---------------------

Segregator PRACTI ECO 600 wysoki z mocowaniem przednim*/ Trash bin PRACTI ECO 600 high with door mount bracket*

				
PB-45-MF342X17-60A	600	1 × 34 l 2 × 17 l	antracyt anthracite	tworzywo plastic

na prowadnicy z cichym domykiem / on slide with soft close





PB-45-MF2X34-60A	600	2 × 34 l	antracyt anthracite	tworzywo plastic
------------------	-----	----------	------------------------	---------------------

Segregator PRACTI ECO 600 / Trash bin PRACTI ECO 600

				
PB-45-600MF-2X27-60A	600	2 × 27 l	antracyt anthracite	tworzywo plastic



Kosze Cargo / Cargo Baskets

CARGO NAROŻNE MOVIX PRO / CORNER CARGO MOVIX PRO**Corner MOVIX PRO 450/500 / Corner MOVIX PRO 450/500**

	
KO-WMC450-01B	stal steel





	
KO-WMC450-60	stal steel
KO-WMC500-01B	stal steel
KO-WMC500-01	stal steel
KO-WMC500-60	stal steel

CARGO BOCZNE MOVIX PRO / SIDE CARGO MOVIX PRO

Cargo boczne MOVIX PRO / Side cargo MOVIX PRO



		
KO-150BO-01	ocynk galvanized	stal steel
KO-200BO-01	ocynk galvanized	stal steel
KO-300BO-01	ocynk galvanized	stal steel
KO-400BO-01	ocynk galvanized	stal steel
KO-150BO-01B	ocynk galvanized	stal steel





		
KO-200BO-01B	ocynk galvanized	stal steel
KO-300BO-01B	ocynk galvanized	stal steel
KO-400BO-01B	ocynk galvanized	stal steel
KO-150BO-60	ocynk galvanized	stal steel
KO-200BO-60	ocynk galvanized	stal steel
KO-300BO-60	ocynk galvanized	stal steel
KO-400BO-60	ocynk galvanized	stal steel
KO-150BO-10	ocynk galvanized	stal steel
KO-200BO-10	ocynk galvanized	stal steel
KO-300BO-10	ocynk galvanized	stal steel





KO-400BO-10	ocynk galvanized	stal steel

Prowadnice z cichym domykiem do cargo MOVIX PRO 150 i 200, lewe

/ Soft-close slides for cargo MOVIX PRO 150 and 200, left



PB-KO450BO-L1	ocynk ocynk	stal steel

Prowadnice z cichym domykiem do cargo MOVIX PRO 150 i 200, prawe

/ Soft-close slides for cargo MOVIX PRO 150 and 200, right



PB-KO450BO-R1	ocynk ocynk	stal steel

Prowadnice z cichym domykiem do cargo MOVIX PRO 300 i 400

/ Soft-close slides for cargo MOVIX PRO 300 and 400



PB-KO450BO	ocynk ocynk	stal steel

Ociekarki / Dish racks

OCIEKARKA BASIC 1 / DRAINER BASIC 1

Ociekarka dwupoziomowa do montażu BASIC 1 / Two tier dish drying rack BASIC 1

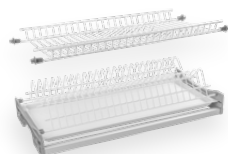

OC-B1400-10	400	biały, white	stal + tworzywo steel + plastic
OC-B1500-10	500	biały, white	
OC-B1600-10	600	biały, white	
OC-B1700-10	700	biały, white	
OC-B1800-10	800	biały, white	
OC-B1900-10	900	biały, white	





	OC-B1400-01	400	chrom, <i>chrome</i>	stal + tworzywo <i>steel + plastic</i>
	OC-B1500-01	500	chrom, <i>chrome</i>	
	OC-B1600-01	600	chrom, <i>chrome</i>	
	OC-B1700-01	700	chrom, <i>chrome</i>	
	OC-B1800-01	800	chrom, <i>chrome</i>	
	OC-B1900-01	900	chrom, <i>chrome</i>	

OCIEKARKA BASIC 3 / DRAINER BASIC 3

Ociekarka dwupoziomowa do montażu BASIC 3 / Two tier dish drying rack BASIC 3

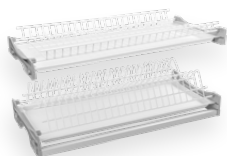

	OC-B3400-10	400	biały <i>white</i>	stal nierdzewna + tworzywo <i>stainless steel + plastic</i>
	OC-B3500-10	500		
	OC-B3600-10	600		
	OC-B3700-10	700		
	OC-B3800-10	800		
	OC-B3900-10	900		
	OC-B3400-01	400	chrom <i>chrome</i>	stal nierdzewna + tworzywo <i>stainless steel + plastic</i>
	OC-B3500-01	500		
	OC-B3600-01	600		
	OC-B3700-01	700		
	OC-B3800-01	800		
	OC-B3900-01	900		

do płyty 16 - 18 mm / for 16-18 mm panels

OCIEKARKA OCA01 / DRAINER OCA01

Ociekarka dwupoziomowa do montażu OCA01 / Two tier dish drying rack OCA01



	OC-A0150-06	stal szczotkowana <i>brushed steel</i>	stal nierdzewna <i>brushed steel</i>
	OC-A0160-06		
	OC-A0170-06		
	OC-A0180-06		
	OC-A0190-06		

OCIEKARKA OCA06 / DRAINER OCA06

Ociekarka jednopoziomowa do montażu OCA06 / Dish drying rack OCA06







	OC-A0660-06	stal szczotkowana <i>brushed steel</i>	stal nierdzewna <i>brushed steel</i>
	OC-A0680-06		

SZUFLADA NA NACZYNIA MOVIX / MOVIX DISH DRAWER

Szuflada na naczynia MOVIX / MOVIX dish drawer





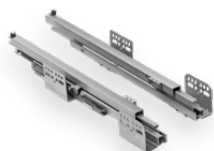

	 mm		
OC-SZD600-01	600	chrom chrome	stal nierdzewna + tworzywo stainless steel + plastic
OC-SZD700-01	700		
OC-SZD800-01	800		
OC-SZD900-01	900		
OC-SZD600-60	600	antracyt anthracite	stal nierdzewna + tworzywo stainless steel + plastic
OC-SZD700-60	700		
OC-SZD800-60	800		
OC-SZD900-60	900		

Prowadnica do szuflady na naczynia MOVIX

/ Drawer slide for MOVIX dish



	 mm		
PB-OC450BO	450	-	stal steel







Zawiasy / Hinges

SILENTO PRO / SILENTO PRO

Zawias SILENTO PRO hydrauliczny z regulacją mimośrodową, nakładany

/ SILENTO PRO hydraulic cup hinge with eccentric adjustment, overlay door









						
ZM-HCSL09-3D	H = 0	-	-	-	nikiel nickel	stal steel
ZM-HCSL09-3D-20	H = 0	-	-	czarny black	-	stal steel

Zawias SILENTO PRO hydrauliczny z regulacją mimośrodową, bliźniaczy

/ SILENTO PRO hydraulic cup hinge with eccentric adjustment, twin overlay door



						
ZM-HCSL08-3D	H = 0	-	-	-	nikiel nickel	stal steel



ZM-HCSL08-3D-20		H = 0	-	-	czarny black	-	stal steel

Zawias SILENTO PRO hydrauliczny z regulacją mimośrodową, wpuszczany
 / SILENTO PRO hydraulic cup hinge with eccentric adjustment, inset door



ZM-HCSL07-3D		H = 0	-	-	-	nikiel nickel	stal steel
ZM-HCSL07-3D-20		H = 0	-	-	czarny black	-	stal steel



Zawias SILENTO PRO do ramek aluminiowych, nakładany
 / SILENTO PRO hinge for aluminium frames, clip-on



ZM-HCSLRALU09-3D		H=0	-	-	-	nikiel nickel	stal steel
ZM-HCSLRALU09-3D-20		H=0	-	-	czarny black	-	stal steel



Zawias SILENTO PRO do ramek aluminiowych, bliźniaczy
 / SILENTO PRO hinge for aluminium frames, twin



ZM-HCSLRALU08-3D		H=0	-	-	-	nikiel nickel	stal steel
ZM-HCSLRALU08-3D-20		H=0	-	-	czarny black	-	stal steel



Zawias SILENTO PRO do ramek aluminiowych, wpuszczany

/ SILENTO PRO hinge for aluminium frames, recessed



ZM-HCSLRALU07-3D	H=0	-	-			nikiel <i>nickel</i>	stal <i>steel</i>
ZM-HCSLRALU07-3D-20	H=0	-	-	czarny <i>black</i>		-	stal <i>steel</i>

Prowadnik krzyżowy

/ Cross mounting plate



PZ-HCSL-H0-BEO	H=0	-	-	-		nikiel <i>nickel</i>	stal <i>steel</i>
PZ-HCSL-H0-BEO-20	H=0	-	-	czarny <i>black</i>		-	stal <i>steel</i>
PZ-HCSL-H0-ZEO	H=0	-	-	-		nikiel <i>nickel</i>	stal <i>steel</i>
PZ-HCSL-H0-ZEO-20	H=0	-	-	czarny <i>black</i>		-	stal <i>steel</i>

Prowadnik z regulacją mimośrodową

/ Mounting plate with adjustment



PZ-HCSL3D-H0-BEO	H=0	-	-	-		nikiel <i>nickel</i>	stal <i>steel</i>
PZ-HCSL3D-H0-BEO-20	H=0	-	-	czarny <i>black</i>		-	stal <i>steel</i>





PZ-HCSL3D-H0-M5	H=0	-	-	-	nikiel nickel		stal steel
PZ-HCSL3D-H0-M5-20	H=0	-	-	czarny black	-		stal steel



Prowadnik krzyżowy + mufy

/ Cross mounting plate + plastic sockets

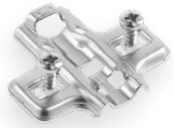

PZ-HCSL-H0-M5	H=0	-	-	-	nikiel nickel		stal steel
PZ-HCSL-H0-M5-20	H=0	-	-	czarny black	-		stal steel



Zaślepki - komplet

/ Cover caps - set



ZM-COVERHCSL-SET	H=0				nikiel nickel		stal steel
ZM-COVERHCSL-SET-20	H=0				nikiel nickel		stal steel



Zawias SILENTO PRO hydrauliczny z regulacją mimośrodową, nakładany

/ SILENTO PRO hydraulic cup hinge with eccentric adjustment, overlay door



ZM-HCSL09-3DBEO	H=0				nikiel nickel		stal steel





ZM-HCSL09-3DBEO-20	H=0			czarny black	-	stal steel

Zawias SILENTO PRO hydrauliczny z regulacją mimośrodową, bliźniaczy
/ SILENTO PRO hydraulic cup hinge with eccentric adjustment, twin overlay door



ZM-HCSL08-3DBEO	H=0			-	nikiel nickel	stal steel
ZM-HCSL08-3DBEO-20	H=0			czarny black	-	stal steel



Zawias SILENTO PRO hydrauliczny z regulacją mimośrodową, wpuszczany
/ SILENTO PRO hydraulic cup hinge with eccentric adjustment, inset door



ZM-HCSL07-3DBEO	H=0			-	nikiel nickel	stal steel
ZM-HCSL07-3DBEO-20	H=0			czarny black	-	stal steel



Zawias SILENTO PRO do ramek aluminiowych, nakładany
/ SILENTO PRO hinge for aluminium frames, overlay door



ZM-HCSLRALU09-3DBEO	H=0			-	nikiel nickel	stal steel
ZM-HCSLRALU09-3DBEO-20	H=0			czarny black	-	stal steel



Zawias SILENTO PRO do ramek aluminiowych, bliźniaczy*/ SILENTO PRO hinge for aluminium frames, twin*

ZM-HCSLRALU08-3DBEO	H=0			-	nikiel nickel	stal steel
ZM-HCSLRALU08-3DBEO-20	H=0			czarny black	-	stal steel

Zawias SILENTO PRO do ramek aluminiowych, wpuszczany*/ SILENTO PRO hinge for aluminium frames, recessed*

ZM-HCSLRALU07-3DBEO	H=0	-	-	-	nikiel nickel	stal steel
ZM-HCSLRALU07-3DBEO-20	H=0	-	-	czarny black	-	stal steel

Zawias SILENTO PRO z ujemnym uskokiem 155° hydrauliczny*/ SILENTO PRO hinge with 155° negative pitch hydraulic*

ZM-HCSLKT155-3D	H=0	-	-	-	nikiel nickel	stal steel
ZM-HCSLKT155-3DBEO	H=0	-	-	-	nikiel nickel	stal steel
ZM-HCSLKT155-3DZEO	H=0	-	-	x2	nikiel nickel	stal steel

Zawias SILENTO PRO bez sprężyny, nakładany

/ SILENTO PRO hinge without spring, clip-on



ZP-SLCA09-3D	H=0	-	-	-	-	nikiel nickel	stal steel
ZP-SLCA09-3DBEO	H=0	-	-	-	-	nikiel nickel	stal steel

Zawias SILENTO PRO bez sprężyny, bliźniaczy

/ SILENTO PRO hinge without spring, twin



ZP-SLCA08-3D	H=0	-	-	-	-	nikiel nickel	stal steel
ZP-SLCA08-3DBEO	H=0	-	-	-	-	nikiel nickel	stal steel

Zawias SILENTO PRO bez sprężyny, wpuszczany

/ SILENTO PRO hinge without spring, recessed



ZP-SLCA07-3D	H=0	-	-	-	-	nikiel nickel	stal steel
ZP-SLCA07-3DBEO	H=0	-	-	-	-	nikiel nickel	stal steel

Zawias SILENTO PRO do ramek aluminiowych, wpuszczany, bez sprężyny
 / SILENTO PRO hinge for aluminium frames, without spring, clip-on



ZP-SLCARALU09-3DBEO	H=0	-	-	-	nikiel nickel		stal steel
ZP-SLCARALU09-3DBEO-20	H=0	-	-	czarny black	-		stal steel

Zawias SILENTO PRO do ramek aluminiowych, bliźniaczy, bez sprężyny
 / SILENTO PRO hinge for aluminium frames, without spring, twin



ZP-SLCARALU08-3DBEO	H=0	-	-	-	nikiel nickel		stal steel
ZP-SLCARALU08-3DBEO-20	H=0	-	-	czarny black	-		stal steel

Zawias SILENTO PRO do ramek aluminiowych, wpuszczany, bez sprężyny
 / SILENTO PRO hinge for aluminium frames, without spring, recessed



ZP-SLCARALU07-3DBEO	H=0				czarny black	-	stal steel
ZP-SLCARALU07-3DBEO-20	H=0				czarny black	-	stal steel

ECHC / ECHC

Zawias hydrauliczny, nakładany / Hydraulic cup hinge, overlay door



ZM-ECHC09BEO	H=0	x4	-	-	nikiel nickel	stal steel
ZM-ECHC09ZEO	H=0	x2	-	-	nikiel nickel	stal steel

Zawias hydrauliczny, bliźniaczy / Hydraulic cup hinge, twin overlay door



ZM-ECHC08BEO	H=0	x4	-	-	nikiel nickel	stal steel
ZM-ECHC08ZEO	H=0	x2	x2	-	nikiel nickel	stal steel

Zawias hydrauliczny, wpuszczany / Hydraulic cup hinge, inset door



ZM-ECHC07BEO	H=0	x4	-	-	nikiel nickel	stal steel
ZM-ECHC07ZEO	H=0	x2	x2	-	nikiel nickel	stal steel

Zawias hydrauliczny, nakładany
/ Hydraulic cup hinge, overlay door



ZM-ECHC09H04-BE	H=0	x6	-	-	nikiel nickel	stal steel	

Zawias hydrauliczny, bliźniaczy
/ Hydraulic cup hinge, twin overlay door



ZM-ECHC08H04-BE	H=0	x6	-	-	nikiel nickel	stal steel	

Zawias hydrauliczny, wpuszczany
/ Hydraulic cup hinge, inset door



ZM-ECHC07H04-BE	H=0	x6	-	-	nikiel nickel	stal steel	

Zawias hydrauliczny nakładany, z regulacją mimośrodową
/ Hydraulic cup hinge with eccentric adjustment, straight, clip-on



ZM-ECHC09-3DBEO	H=0	x4	-	-	nikiel nickel	stal steel	

Zawias hydrauliczny półwpuszczany z regulacją mimośrodową
/ Hydraulic cup hinge with eccentric adjustment, half-overlay door



ZM-ECHC08-3DBEO	H=0	x4	-	-	nikiel nickel	stal steel	

Zawias hydrauliczny wpuszczany, z regulacją mimośrodową
/ Hydraulic cup hinge with eccentric adjustment, inset door



ZM-ECHC07-3DBEO	H=0	x4	-	-	-	nikiel nickel	stal steel

SOLID PRO (DCHC) / SOLID PRO (DCHC)

Zawias hydrauliczny, nakładany
/ Hydraulic cup hinge, overlay door



ZM-DCHCB09-3DBEO-20	H=0	-	-	czarny black	-	stal steel	

Zawias hydrauliczny, bliźniaczy
/ Hydraulic cup hinge, twin overlay door



ZM-DCHCB08-3DBEO-20	H=0	-	-	czarny black	-	stal steel	

Zawias hydrauliczny, wpuszczany
/ Hydraulic cup hinge, inset door



ZM-DCHCB07-3DBEO-20	H=0	-	-	czarny black	-	stal steel	

SOLID PLUS (DCHC) / SOLID PLUS (DCHC)

Zawias hydrauliczny, nakładany
/ Hydraulic cup hinge, overlay door



ZM-DCHC09-3DBEO	H=0	-	-	-	-	nikiel nickel	stal steel



ZM-DCHC09-3DZEO	H=0	-	x 2	-	-	nikiel nickel	stal steel

Zawias hydrauliczny, bliźniaczy

/ Hydraulic cup hinge, twin overlay door



ZM-DCHC08-3DBEO	H=0	-	-	-	-	nikiel nickel	stal steel
ZM-DCHC08-3DZEO	H=0	-	x 2	-	-	nikiel nickel	stal steel



Zawias hydrauliczny, wpuszczany

/ Hydraulic cup hinge, inset door



ZM-DCHC07-3DBEO	H=0	-	-	-	-	nikiel nickel	stal steel
ZM-DCHC07-3DZEO	H=0	-	x 2	-	-	nikiel nickel	stal steel



HCKT / HCKT

Zawias kątowy 30°, hydrauliczny

/ Hydraulic corner cup hinge 30°









ZM-HCKT30-BE-S	H=0	x 4	-	-	-	nikiel nickel	stal steel
ZM-HCKT30-ZE-S	H=0	x 2	x 2	-	-	nikiel nickel	stal steel



Zawias kątowy 45° hydrauliczny

/ Hydraulic corner cup hinge 45°







							
ZM-HCKT45-BE-S	H=0	x 4	-	-	-	nikiel nickel	stal steel
ZM-HCKT45-ZE-S	H=0	x 2	x 2	-	-	nikiel nickel	stal steel

Zawias kątowy 45° z regulacją mimośrodową

/ Corner hinge 45° with eccentric adjustment









							
ZM-HCKT45-3DBEO-S	H=0	-	x 2	-	-	nikiel nickel	stal steel

Zawias równoległy hydrauliczny

/ Parallel hydraulic hinge









							
ZM-HCKT90-BE-S	H=0	x 4	-	-	-	nikiel nickel	stal steel
ZM-HCKT90-ZE-S	H=0	x 2	x 2	-	-	nikiel nickel	stal steel

Zawias równoległy z regulacją mimośrodową

/ Parallel hinge with eccentric adjustment



							
ZM-HCKT90-3DBEO-S	H=0	x 4	-	-	-	nikiel nickel	stal steel

Zawias równoległy – krótkie ramię ze sprężyną dociągającą*/ Parallel hinge – short arm*

ZM-HCKTK90-ZE	H=0	x 2	–	–	–	nikiel <i>nickel</i>	stal <i>steel</i>

Zawias 165° hydrauliczny*/ Hydraulic hinge 165°*

ZM-HCKT165BE-S	H=0	–	–	–	–	nikiel <i>nickel</i>	stal <i>steel</i>
ZM-HCKT165ZE-S	H=0	–	x 2	–	–	nikiel <i>nickel</i>	stal <i>steel</i>

Zawias 165° hydrauliczny z regulacją mimośrodową*/ Hydraulic hinge 165° with eccentric adjustment*





ZM-HCKT165-3DBEO-S	H=0	–	–	–	–	nikiel <i>nickel</i>	stal <i>steel</i>

PODNOŚNIKI / Lifts

HORIZON / HORIZON

Podnośnik HORIZON soft close / HORIZON soft close lift



	Orientacja wysokości frontu / Front height orientation	 kg	Współczynnik F / F coefficient			
PD-H-LIGHT-10	300 - 450	2-5	500-1350	LIGHT	biały white	stal + tworzywo steel + plastic
PD-H-LIGHT-80	300 - 450	2-5	500-1351	LIGHT	antracyt anthracite	stal + tworzywo steel + plastic
PD-H-LIGHT-20	300 - 450	2-5	500-1352	LIGHT	czarny black	stal + tworzywo steel + plastic
PD-H-MEDIUM-10	300-650	2,8-7	1100-2250	MEDIUM	biały white	stal + tworzywo steel + plastic
PD-H-MEDIUM-80	300-650	2,8-7	1100-2251	MEDIUM	antracyt anthracite	stal + tworzywo steel + plastic
PD-H-MEDIUM-20	300-650	2,8-7	1100-2252	MEDIUM	czarny black	stal + tworzywo steel + plastic
PD-H-STRONG-10	350-650	4,5-10	2000-4050	STRONG	biały white	stal + tworzywo steel + plastic
PD-H-STRONG-80	350-650	4,5-10	2000-4051	STRONG	antracyt anthracite	stal + tworzywo steel + plastic
PD-H-STRONG-20	350-650	4,5-10	2000-4052	STRONG	czarny black	stal + tworzywo steel + plastic











PD-H-STRONG-PLUS-10	400-650	8-12	3500-5200	EXTRA STRONG	biały white	stal + tworzywo steel + plastic
PD-H-STRONG-PLUS-80	400-650	8-12	3500-5201	EXTRA STRONG	antracyt anthracite	stal + tworzywo steel + plastic
PD-H-STRONG-PLUS-20	400-650	8-12	3500-5202	EXTRA STRONG	czarny black	stal + tworzywo steel + plastic

Podnośnik HORIZON push to open
/ HORIZON push to open lift



	Orientacja wysokości frontu / Front height orientation	 / 	Współczynnik F / F coefficient			
PD-H-P2O-LIGHT-10	300 - 450	2-5	500-1352	LIGHT	biały white	stal + tworzywo steel + plastic
PD-H-P2O-LIGHT-80	300 - 450	2-5	500-1353	LIGHT	antracyt anthracite	stal + tworzywo steel + plastic
PD-H-P2O-LIGHT-20	300 - 450	2-5	500-1354	LIGHT	czarny black	stal + tworzywo steel + plastic
PD-H-P2O-MEDIUM-10	300-650	2,8-7	1100-2250	MEDIUM	biały white	stal + tworzywo steel + plastic
PD-H-P2O-MEDIUM-80	300-650	2,8-7	1100-2251	MEDIUM	antracyt anthracite	stal + tworzywo steel + plastic
PD-H-P2O-MEDIUM-20	300-650	2,8-7	1100-2252	MEDIUM	czarny black	stal + tworzywo steel + plastic



		Orientacja wysokości frontu / Front height orientation		Współczynnik F / F coefficient			
	PD-H-P2O-STRONG-10	350-650	4,5-10	2000-4052	STRONG	biały white	stal + tworzywo steel + plastic
	PD-H-P2O-STRONG-80	350-650	4,5-10	2000-4052	STRONG	antracyt anthracite	stal + tworzywo steel + plastic
	PD-H-P2O-STRONG-20	350-650	4,5-10	2000-4052	STRONG	czarny black	stal + tworzywo steel + plastic
	PD-H-P2O-STRONG-PLUS-10	400-650	8-12	3500-5200	EXTRA STRONG	biały white	stal + tworzywo steel + plastic
	PD-H-P2O-STRONG-PLUS-80	400-650	8-12	3500-5201	EXTRA STRONG	antracyt anthracite	stal + tworzywo steel + plastic
	PD-H-P2O-STRONG-PLUS-20	400-650	8-12	3500-5202	EXTRA STRONG	czarny black	stal + tworzywo steel + plastic

MINILIFT NEW / MINILIFT NEW

Podnośnik MINILIFTNEW / MINILIFTNEW lift



			Wymiary frontu / Front dimensions			Zalecana ilość podnośników (szt.) / Recommended number of lifts		
			Wysokość / Height	Szerokość / Width				
	PD-MINILIFTNEW-LIGHT	LIGHT	300-400	500-800	2-3	1	chrom chrome	stal steel
	PD-MINILIFTNEW-LIGHT-20	LIGHT	300-400	500-1000	3,1-4	2	czarny black	stal steel
	PD-MINILIFTNEW-MEDIUM	MEDIUM	300-450	500-1000	3,5-4,5	1	chrom chrome	stal steel





	i	Wymiary frontu / Front dimensions		kg T	Zalecana ilość podnośników (szt.) / Recommended number of lifts		
		Wysokość / Height	Szerokość / Width				
PD-MINILIFTNEW-MEDIUM-20	MEDIUM	300-450	500-1200	5,5-7,5	2	czarny black	stal steel
PD-MINILIFTNEW-STRONG	STRONG	380-550	500-1200	5-6	1	chrom chrome	stal steel
PD-MINILIFTNEW-STRONG-20	STRONG	380-550	500-1200	6,5-10	2	czarny black	stal steel

Pozostałe akcesoria meblowe / Other furniture accessories

ODBOJNIK SALTO NOWA / BUMPER SALTO NOVA

Odbojnik wpuszczany krótki z końcówką magnetyczną
/ Bumper, recessed, short magnetic tip

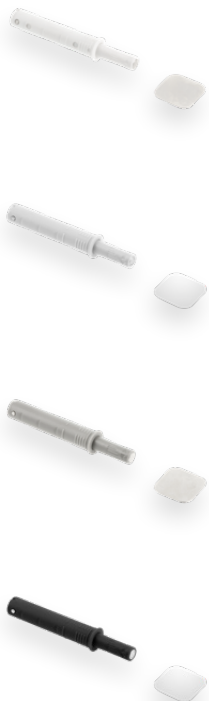





AM-SVW-KR-MG-10	biały white	min. 2,5	tworzywo, plastic
AM-SVW-KR-MG-30	szary gray	min. 2,5	tworzywo, plastic
AM-SVW-KR-MG-60	antracyt anthracite	min. 2,5	tworzywo, plastic
AM-SVW-KR-MG-20	czarny black	min. 2,5	tworzywo, plastic

Odbojnik wpuszczany krótki z końcówką kauczukową

/ Bumper, recessed, short with rubber tip







			
AM-SVW-KR-GM-10	biały <i>white</i>	min. 2,5	tworzywo, <i>plastic</i>
AM-SVW-KR-GM-30	szary <i>gray</i>	min. 2,5	tworzywo, <i>plastic</i>
AM-SVW-KR-GM-60	antracyt <i>anthracite</i>	min. 2,5	tworzywo, <i>plastic</i>
AM-SVW-KR-GM-20	czarny <i>black</i>	min. 2,5	tworzywo, <i>plastic</i>





Odbojnik wpuszczany długi z końcówką magnetyczną

/ Bumper, recessed, long magnetic tip







			
AM-SVW-DL-MG-10	biały <i>white</i>	min. 2,5	tworzywo, <i>plastic</i>
AM-SVW-DL-MG-30	szary <i>gray</i>	min. 2,5	tworzywo, <i>plastic</i>
AM-SVW-DL-MG-60	antracyt <i>anthracite</i>	min. 2,5	tworzywo, <i>plastic</i>
AM-SVW-DL-MG-20	czarny <i>black</i>	min. 2,5	tworzywo, <i>plastic</i>

Odbojnik wpuszczany długi z końcówką kauczukową*/ Bumper, recessed, long with rubber tip*

			
AM-SVW-DL-GM-10	biały <i>white</i>	min. 2,5	tworzywo, <i>plastic</i>
AM-SVW-DL-GM-30	szary <i>gray</i>	min. 2,5	tworzywo, <i>plastic</i>
AM-SVW-DL-GM-60	antracyt <i>anthracite</i>	min. 2,5	tworzywo, <i>plastic</i>
AM-SVW-DL-GM-20	czarny <i>black</i>	min. 2,5	tworzywo, <i>plastic</i>





Odbojnik krótki z adapterem z końcówką magnetyczną*/ Bumper, short, with adapter magnetic tip*

			
AM-SVN-KR-MG-10	biały <i>white</i>	min. 2,5	tworzywo, <i>plastic</i>
AM-SVN-KR-MG-30	szary <i>gray</i>	min. 2,5	tworzywo, <i>plastic</i>
AM-SVN-KR-MG-60	antracyt <i>anthracite</i>	min. 2,5	tworzywo, <i>plastic</i>
AM-SVN-KR-MG-20	czarny <i>black</i>	min. 2,5	tworzywo, <i>plastic</i>

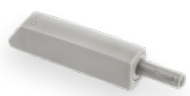
Odbojnik krótki z adapterem z końcówką kauczukową

/ Bumper, short, with adapter with rubber tip





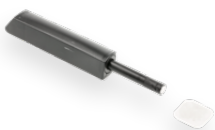
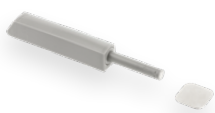

			
AM-SVN-KR-GM-10	biały white	min. 2,5	tworzywo, plastic
AM-SVN-KR-GM-30	szary gray	min. 2,5	tworzywo, plastic
AM-SVN-KR-GM-60	antracyt anthracite	min. 2,5	tworzywo, plastic
AM-SVN-KR-GM-20	czarny black	min. 2,5	tworzywo, plastic

Odbojnik długi z adapterem z końcówką magnetyczną

/ Bumper, long, with adapter magnetic tip



			
AM-SVN-DL-MG-10	biały white	min. 2,5	tworzywo, plastic
AM-SVN-DL-MG-30	szary gray	min. 2,5	tworzywo, plastic
AM-SVN-DL-MG-60	antracyt anthracite	min. 2,5	tworzywo, plastic
AM-SVN-DL-MG-20	czarny black	min. 2,5	tworzywo, plastic

Odbojnik długi z adapterem z końcówką kauczukową

/ Bumper, long, with adapter with rubber tip

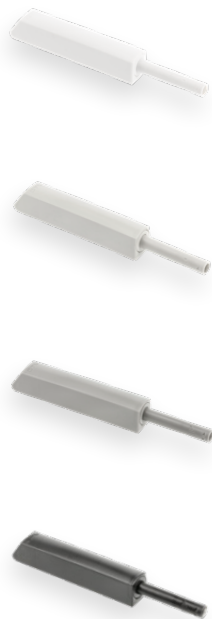





			
AM-SVN-DL-GM-10	biały white	min. 2,5	tworzywo, plastic
AM-SVN-DL-GM-30	szary gray	min. 2,5	tworzywo, plastic
AM-SVN-DL-GM-60	antracyt anthracite	min. 2,5	tworzywo, plastic
AM-SVN-DL-GM-20	czarny black	min. 2,5	tworzywo, plastic

KRATKI WENTYLACYJNE / VENTILATION GRILLES**Kratka wentylacyjna W60245**

/ Plinth vent W60245



		Wymiar zewnętrzny / External size		
KK-W60245-M0	przepustowość powietrza – 42 cm ² air throughput – 42 cm ²	245 × 60 mm	aluminium aluminium	aluminium aluminium
KK-W60245-M1	przepustowość powietrza – 42 cm ² air throughput – 42 cm ²	245 × 60 mm	biały white	aluminium aluminium
KK-W60245-M2	przepustowość powietrza – 42 cm ² air throughput – 42 cm ²	245 × 60 mm	czarny black	aluminium aluminium
KK-W60245-M6	przepustowość powietrza – 42 cm ² air throughput – 42 cm ²	245 × 60 mm	stal szczerkowana brushed steel	aluminium aluminium
KK-W60245-21	przepustowość powietrza – 42 cm ² air throughput – 42 cm ²	245 × 60 mm	złoty gold	aluminium aluminium
KK-W60245-24	przepustowość powietrza – 42 cm ² air throughput – 42 cm ²	245 × 60 mm	jasny antracyt light anthracite	aluminium aluminium

Kratka wentylacyjna D50-80

/ Plinth vent D50-80

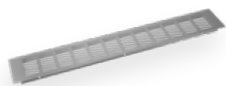

		Wymiar zewnętrzny / External size		
KK-D50-80-06	przepustowość powietrza – 108 cm ² air throughput – 108 cm ²	500 × 80 mm	stal szczotkowana brushed steel	aluminium aluminium

Kratka wentylacyjna D50-100

/ Plinth vent D50-100

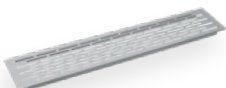

		Wymiar zewnętrzny / External size		
KK-D50100-06	przepustowość powietrza – 130 cm ² air throughput – 130 cm ²	500 × 100 mm	stal szczotkowana brushed steel	aluminium aluminium

Kratka wentylacyjna W60800

/ Plinth vent W60800

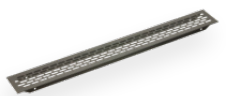
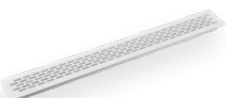

		Wymiar zewnętrzny / External size		
KK-W60800-M0	przepustowość powietrza – 106,25 cm ² air throughput – 106,25 cm ²	484 × 60 mm	aluminium aluminium	aluminium aluminium
KK-W60800-M1	przepustowość powietrza – 106,25 cm ² air throughput – 106,25 cm ²	484 × 60 mm	biały white	aluminium aluminium
KK-W60800-M2	przepustowość powietrza – 106,25 cm ² air throughput – 106,25 cm ²	484 × 60 mm	czarny black	aluminium aluminium
KK-W60800-06	przepustowość powietrza – 106,25 cm ² air throughput – 106,25 cm ²	484 × 60 mm	stal szczotkowana brushed steel	aluminium aluminium
KK-W60800-21	przepustowość powietrza – 106,25 cm ² air throughput – 106,25 cm ²	484 × 60 mm	złoty gold	aluminium aluminium
KK-W60800-24	przepustowość powietrza – 106,25 cm ² air throughput – 106,25 cm ²	484 × 60 mm	jasny antracyt light anthracite	aluminium aluminium

Kratka wentylacyjna W80800

/ Plinth vent W80800

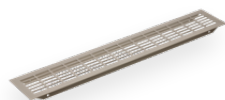
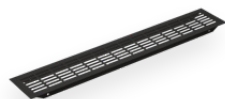
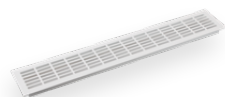

		Wymiar zewnętrzny / External size		
KK-W80800-D0	przepustowość powietrza – 146 cm ² air throughput – 146 cm ²	480 × 80 mm	aluminium aluminium	aluminium aluminium
KK-W80800-D1	przepustowość powietrza – 146 cm ² air throughput – 146 cm ²	480 × 80 mm	biały white	aluminium aluminium
KK-W80800-D2	przepustowość powietrza – 146 cm ² air throughput – 146 cm ²	480 × 80 mm	czarny black	aluminium aluminium
KK-W80800-06	przepustowość powietrza – 146 cm ² air throughput – 146 cm ²	480 × 80 mm	stal szczotkowana brushed steel	aluminium aluminium
KK-W80800-21	przepustowość powietrza – 146 cm ² air throughput – 146 cm ²	480 × 80 mm	złoty gold	aluminium aluminium
KK-W80800-24	przepustowość powietrza – 146 cm ² air throughput – 146 cm ²	480 × 80 mm	jasny antracyt light anthracite	aluminium aluminium

Kratka wentylacyjna W80480

/ Plinth vent W80480

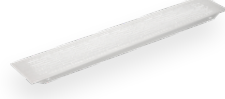
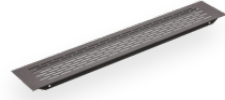

		Wymiar zewnętrzny / External size		
KK-W80480-05	przepustowość powietrza – 90 cm ² air throughput – 90 cm ²	480 × 80 mm	aluminium aluminium	aluminium aluminium
KK-W80480-10	przepustowość powietrza – 90 cm ² air throughput – 90 cm ²	480 × 80 mm	biały white	aluminium aluminium
KK-W80480-20M	przepustowość powietrza – 90 cm ² air throughput – 90 cm ²	480 × 80 mm	czarny black	aluminium aluminium
KK-W80480-06	przepustowość powietrza – 90 cm ² air throughput – 90 cm ²	480 × 80 mm	stal szczotkowana brushed steel	aluminium aluminium
KK-W80480-21	przepustowość powietrza – 90 cm ² air throughput – 90 cm ²	480 × 80 mm	złoty gold	aluminium aluminium
KK-W80480-24	przepustowość powietrza – 90 cm ² air throughput – 90 cm ²	480 × 80 mm	jasny antracyt light anthracite	aluminium aluminium

ELEMENTY ŁĄCZENIOWE / FURNITURE FITTING

Listwa montażowa / Mounting strip



	 mm	Wysokość / Heig	Grubość / Thickness		
LO-M2M-00-125-A	2000	42	1,2	ocynk galvanized	stal steel

Zawieszka meblowa FORZA / Furniture hanger FORZA



	 kg			
ZK-FORZA-ZAW-KPL	150 / 2 szt. 150 / 2 pcs	1 kpl. = L+P 1 set = L+R	srebrny silver	stal steel

Zaślepka do zawieszki FORZA / FORZA cover

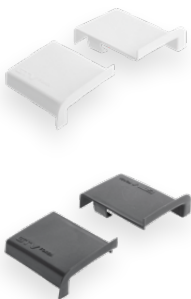

ZK-FORZA-ZAS-KPL-01	1 kpl. = L+P 1 set = L+R	biały white	tworzywo, plastic
ZK-FORZA-ZAS-KPL-020		czarny black	

NÓŻKI COKOŁOWE / PLINTH LEGS

Nóżka DPD z regulacją / Adjustable leg DPD







	 mm	 kg		
NM-DPD20-100	95 – 165	60	czarny black	tworzywo, plastic

Klip do nóżki DPD / XClip for legs DPD





NM-KL-DPL-20	czarny black	tworzywo, plastic

Nóżka DPA / Adjustable leg DPA

	 H mm	 T		
NM-DPA20-100	87 – 120	100	czarny black	tworzywo, plastic
NM-DPA20-100W	87 – 120	100	czarny black	tworzywo, plastic
NM-DPA20-150	137 – 170	100	czarny black	tworzywo, plastic
NM-DPA20-150W	137 – 170	100	czarny black	tworzywo, plastic

Klip do nóżki DPA / Clip for legs DPA

		
NM-KL-DPA-20	czarny black	tworzywo, plastic





Klucz do regulacji nóżek DPA / DPD

/ Leg adjustment key DPA / DPD







		
NM-KLUCZREG-DPADPD	czarny black	tworzywo, plastic

Nóżka z regulacją MLA / Adjustable leg MLA



	 H mm	 T		
NM-MLA-50-75	50-75	450	czarny black	tworzywo, plastic
NM-MLA-65-85	65 – 85	450	czarny black	tworzywo, plastic
NM-MLA-85-125	85 – 125	450	czarny black	tworzywo, plastic
NM-MLA-95-145	95 – 145	450	czarny black	tworzywo, plastic



		 H mm	 kg		
	NM-MLA-125-195	137 – 170	100	czarny black	tworzywo, plastic

Klip do nóżki MILA / Clip for legs MLA



			
	NM-MLA-KL	czarny black	tworzywo, plastic

SYSTEMY BEZUCHWYTOWE / Handleless systems

SYSTEM BEZUCHWYTOWY VELLO / VELLO HANDLELESS SYSTEM

System bezuchwytowy VELLO profil L / VELLO handleless system L-profile

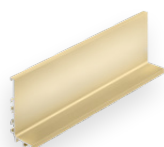

		 C mm	 L mm		
	PA-VELLO-L3M-05	do cięcia to cut	3000	aluminium aluminium	aluminium aluminium
	PA-VELLO-L4M-05		4100		
	PA-VELLO-L3M-06	do cięcia to cut	3000	stal szcztokowana brushed steel	aluminium aluminium
	PA-VELLO-L4M-06		4100		
	PA-VELLO-L3M-10	do cięcia to cut	3000	biały white	aluminium aluminium
	PA-VELLO-L4M-10		4100		
	PA-VELLO-L3M-20M	do cięcia to cut	3000	czarny mat black matt	aluminium aluminium
	PA-VELLO-L4M-20M		4100		
	PA-VELLO-L4M-21	do cięcia to cut	4100	złoty gold	aluminium aluminium





Zaślepka niepełna do profilu L, lewa / Partial cover cap for profile L, left



				
PA-ZASVELLO-LNL-05	-	-	aluminium aluminium	tworzywo, plastic
PA-ZASVELLO-LNL-06	-	-	stal szcztokowana brushed steel	tworzywo, plastic
PA-ZASVELLO-LNL-10	-	-	biały white	tworzywo, plastic
PA-ZASVELLO-LNL-20M	-	-	czarny mat black matt	tworzywo, plastic
PA-ZASVELLO-LNL-21	-	-	złoty gold	tworzywo, plastic

Zaślepka niepełna do profilu L, prawa / Cover cap for profile L, right



				
PA-ZASVELLO-LNP-05	-	-	aluminium aluminium	tworzywo, plastic
PA-ZASVELLO-LNP-06	-	-	stal szcztokowana brushed steel	tworzywo, plastic
PA-ZASVELLO-LNP-10	-	-	biały white	tworzywo, plastic
PA-ZASVELLO-LNP-20M	-	-	czarny mat black matt	tworzywo, plastic
PA-ZASVELLO-LNP-21	-	-	złoty gold	tworzywo, plastic





Zaślepka pełna do profilu L, lewa / Full cover cap for profile L, left



	 C mm	 L mm		
PA-ZASVELLO-LPL-05	-	-	aluminium aluminium	tworzywo, plastic
PA-ZASVELLO-LPL-06	-	-	stal szcztokowana brushed steel	tworzywo, plastic
PA-ZASVELLO-LPL-10	-	-	biały white	tworzywo, plastic
PA-ZASVELLO-LPL-20M	-	-	czarny mat black matt	tworzywo, plastic
PA-ZASVELLO-LPL-21	-	-	złoty gold	tworzywo, plastic

Zaślepka pełna do profilu L, prawa / Full cover cap for profile L, right



	 C mm	 L mm		
PA-ZASVELLO-LPP-05	-	-	aluminium aluminium	tworzywo, plastic
PA-ZASVELLO-LPP-06	-	-	stal szcztokowana brushed steel	tworzywo, plastic
PA-ZASVELLO-LPP-10	-	-	biały white	tworzywo, plastic
PA-ZASVELLO-LPP-20M	-	-	czarny mat black matt	tworzywo, plastic
PA-ZASVELLO-LPP-21	-	-	złoty gold	tworzywo, plastic

Łącznik wewnętrzny dla profilu L / Internal connector for L profile

				
PA-LACZVELLO-LIN-05	-	-	aluminium aluminium	tworzywo, plastic
PA-LACZVELLO-LIN-06	-	-	stal szcztokowana brushed steel	tworzywo, plastic
PA-LACZVELLO-LIN-10	-	-	biały white	tworzywo, plastic
PA-LACZVELLO-LIN-20M	-	-	czarny mat black matt	tworzywo, plastic
PA-LACZVELLO-LIN-21	-	-	złoty gold	tworzywo, plastic

Łącznik zewnętrzny dla profilu L / External connector for L profile

				
PA-LACZVELLO-LOUT-05	-	-	aluminium aluminium	tworzywo, plastic
PA-LACZVELLO-LOUT-06	-	-	stal szcztokowana brushed steel	tworzywo, plastic
PA-LACZVELLO-LOUT-10	-	-	biały white	tworzywo, plastic
PA-LACZVELLO-LOUT-20M	-	-	czarny mat black matt	tworzywo, plastic
PA-LACZVELLO-LOUT-21	-	-	złoty gold	tworzywo, plastic





System bezuchwytowy VELLO profil C / VELLO handleless system C-profile



	 C mm	 L mm		
PA-VELLO-C3M-05	do cięcia to cut	3000	aluminium aluminium	aluminium aluminium
PA-VELLO-C4M-05		4100		
PA-VELLO-C3M-06	do cięcia to cut	3000	stal szczerkowana brushed steel	aluminium aluminium
PA-VELLO-C4M-06		4100		
PA-VELLO-C3M-10	do cięcia to cut	3000	biały white	aluminium aluminium
PA-VELLO-C4M-10		4100		
PA-VELLO-C3M-20M	do cięcia to cut	3000	czarny mat black matt	aluminium aluminium
PA-VELLO-C4M-20M		4100		
PA-VELLO-C4M-21	do cięcia to cut	4100	złoty gold	aluminium aluminium

Zaślepka niepełna profil C / Cover cap, C-profile



	 C mm	 L mm		
PA-ZASVELLO-CN-05	-	-	aluminium aluminium	tworzywo, plastic
PA-ZASVELLO-CN-06	-	-	stal szczerkowana brushed steel	tworzywo, plastic
PA-ZASVELLO-CN-10	-	-	biały white	tworzywo, plastic
PA-ZASVELLO-CN-20M	-	-	czarny mat black matt	tworzywo, plastic
PA-ZASVELLO-CN-21	-	-	złoty gold	tworzywo, plastic



Zaślepka pełna profil C / Cover cap, C-profile



	 C mm	 L mm		
PA-ZASVELLO-CP-05	-	-	aluminium aluminium	tworzywo, plastic
PA-ZASVELLO-CP-06	-	-	stal szcztokowana brushed steel	tworzywo, plastic
PA-ZASVELLO-CP-10	-	-	biały white	tworzywo, plastic
PA-ZASVELLO-CP-20M	-	-	czarny mat black matt	tworzywo, plastic
PA-ZASVELLO-CP-21	-	-	złoty gold	tworzywo, plastic





Łącznik wewnętrzny profil C / Internal connector for C profile



	 C mm	 L mm		
PA-LACZVELLO-CIN-05	-	-	aluminium aluminium	tworzywo, plastic
PA-LACZVELLO-CIN-06	-	-	stal szcztokowana brushed steel	tworzywo, plastic
PA-LACZVELLO-CIN-10	-	-	biały white	tworzywo, plastic
PA-LACZVELLO-CIN-20M	-	-	czarny mat black matt	tworzywo, plastic
PA-LACZVELLO-CIN-21	-	-	złoty gold	tworzywo, plastic

Łącznik zewnętrzny profil C / External connector for C profile



	 C mm	 L mm		
PA-LACZVELLO-COUT-05	-	-	aluminium aluminium	tworzywo, plastic
PA-LACZVELLO-COUT-06	-	-	stal szcztokowana brushed steel	tworzywo, plastic
PA-LACZVELLO-COUT-10	-	-	biały white	tworzywo, plastic
PA-LACZVELLO-COUT-20M	-	-	czarny mat black matt	tworzywo, plastic
PA-LACZVELLO-COUT-21	-	-	złoty gold	tworzywo, plastic

System bezuchwytowy VELLO TJ / VELLO TJ handleless system



	 C mm	 L mm		
PA-VELLO-TJ3M-05	do cięcia to cut	3000	aluminium aluminium	aluminium aluminium
PA-VELLO-TJ3M-06	do cięcia to cut	3000	stal szcztokowana brushed steel	aluminium aluminium
PA-VELLO-TJ3M-10	do cięcia to cut	3000	biały white	aluminium aluminium
PA-VELLO-TJ3M-20M	do cięcia to cut	3000	czarny mat black matt	aluminium aluminium
PA-VELLO-TJ3M-21	do cięcia to cut	3000	złoty gold	aluminium aluminium

System bezuchwytowy VELLO TD / VELLO TD handleless system

	 C mm	 L mm		
PA-VELLO-TD3M-05	do cięcia to cut	3000	aluminium aluminium	aluminium aluminium
PA-VELLO-TD3M-06	do cięcia to cut	3000	stal szcziotkowana brushed steel	aluminium aluminium
PA-VELLO-TD3M-10	do cięcia to cut	3000	biały white	aluminium aluminium
PA-VELLO-TD3M-20M	do cięcia to cut	3000	czarny mat black matt	aluminium aluminium
PA-VELLO-TD3M-21	do cięcia to cut	3000	złoty gold	aluminium aluminium

System bezuchwytowy VELLO wieńcowy / VELLO rim handleless system

	 C mm	 L mm		
PA-VELLO-WN3M16-21	do cięcia to cut	300/16	złoty gold	aluminium aluminium
PA-VELLO-WN3M16-05	do cięcia to cut	300/16	aluminium aluminium	aluminium aluminium
PA-VELLO-WN3M18-05	do cięcia to cut	300/18	aluminium aluminium	aluminium aluminium
PA-VELLO-WN3M18-10	do cięcia to cut	300/18	biały white	aluminium aluminium
PA-VELLO-WN3M18-20M	do cięcia to cut	300/18	czarny mat black matt	aluminium aluminium
PA-VELLO-WN3M18-21	do cięcia to cut	300/18	złoty gold	aluminium aluminium

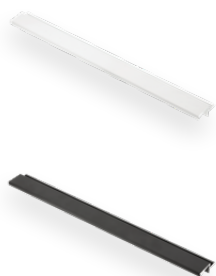

PA-VELLO-WN3M16-10	do cięcia to cut	300/16	biały white	aluminium aluminium
PA-VELLO-WN3M16-20M	do cięcia to cut	300/16	czarny black	aluminium aluminium

Łącznik / Connector



	Wymiary / Dimensions		
PA-MOUNT-GL-00	30 × 40	-	stal steel

Oświetlenie meblowe / Furniture lighting















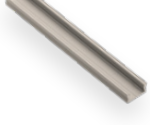
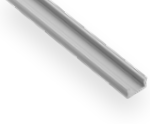

PROFILE GLAX / GLAX PROFILE

Profil GLAX nakładany, micro / GLAX profile surface mounted, micro

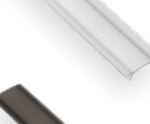

PA-GLAXMICNK-AL	2	profil profile	srebrny silver	aluminium aluminium
PA-GLAXMICNK3M-AL	3			
PA-OSMLGLAXMIC-00N	2	osłonka micro cover micro	mleczna frosted	PC
PA-OSMLGLAXMIC3M-00N	3			
PA-OSMLGLAXMIC45M-00N	45			
PA-ZASGLAXMICNK-00	-	zaślepka end cap	szary gray	ABS
PA-SPRGLAXMIC-00	-	uchwyt mounting clip	srebrny silver	stal nierdzewna stainless steel

Profil GLAX nakładany, mini / GLAX profile mini surface mounted



		 mm					
	PA-GLAXMNK-AL	2	profil profile	srebrny silver	aluminium aluminium		
	PA-GLAXMNK-AL-20M			czarny black			
	PA-GLAXMNK-AL-10			biały white			
	PA-GLAXMNK-AL-90			szampan champagne			
	PA-GLAXMNK3M-AL	3	profil profile	srebrny silver	aluminium aluminium		
	PA-GLAXMNK3M-AL-20M			czarny black			
	PA-GLAXMNK3M-AL-10			biały white			
	PA-OSMLGLAXM-00	2	osłonka mini cover mini	mleczna frosted	PC		
	PA-OSMLGLAXM3M-00	3		transparentna transparent			
	PA-OSTRGLAXM-00	2		czarny black			
	PA-OSTRGLAXM3M-00	3					
	PA-OSCLGLAXM-00	2		osłonka kwadratowa, square covere		mleczna frosted	PC
	PA-OSCLGLAXM3M-00	3					
	PA-OSMLGLAXMK-00	2	osłonka okrągła round cover	mleczna frosted	PC		
	PA-OSMLGLAXMK3M-00	3					
	PA-OSMLGLAXMO-00	2	osłonka okrągła round cover	mleczna frosted	PC		
	PA-OSMLGLAXMO3M-00	3					





PA-OSCLGLAXM45M-00				czarny black	
PA-OSMLGLAXM45M-00		45	osłonka mini cover mini	mleczna frosted	PC
PA-OSTRGLAXM45M-00				transparentna transparent	
PA-ZASGLAXMNK-00		-	zaślepka standard standard end cap	szary gray	ABS
PA-ZASGLAXMNK-10		-		biały white	
PA-ZASGLAXMNK-90		-		szampan champagne	
PA-ZASGLAXMNK-20M		-		czarny mat black matt	
PA-ZASGLAXMNKK-00		-	zaślepka kwadratowa square end cap	szary gray	ABS
PA-ZASGLAXMNKO-00		-	zaślepka okrągła round end cap	szary gray	
PA-SPRGLAXM-00		-	uchwyt mounting clip	srebrny silver	stal nierdzewna stainless steel

Profil GLAX nakładany, mini / GLAX profile surface mounted

	 mm			
PA-GLAXNK-AL	2	profil profile	srebrny silver	aluminium aluminium
PA-GLAXNK3M-AL	3			
PA-OSMLGLAX-00	2	osłonka mini cover mini	mleczna frosted	PC
PA-OSMLGLAX3M-00	3			
PA-OSTRGLAX-00	2			
PA-OSTRGLAX3M-00	3			
PA-OSTRGLAXM45M-00	45			
PA-OSMLGLAXM45M-00	45		mleczna frosted	
PA-ZASGLAXNK-00	-	zaślepka end cap	szary gray	ABS

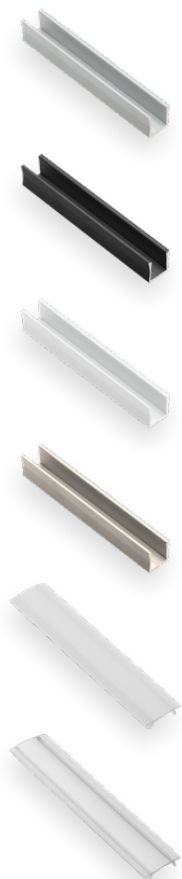
Profil GLAX nakładany mini, wysoki / Profile GLAX surface mounted mini, high

	 mm			
PA-GLAXMNKW-AL	2	profil profile	srebrny silver	aluminium aluminium
PA-GLAXMNKW-AL-20M			czarny black	
PA-GLAXMNKW-AL-10			biały white	
PA-GLAXMNKW-AL-90			szampan champagne	
PA-OSMLGLAXM-00	2	osłonka mini cover mini	mleczna frosted	PC
PA-OSTRGLAXM-00			transparentna transparent	







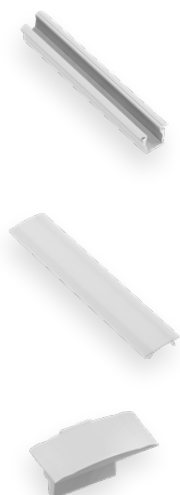

PA-OSCLGLAXM-00	2	osłonka mini cover mini	czarny black	PC
PA-OSCLGLAXM45M-00			czarny black	
PA-OSMLGLAXM45M-00	45	osłonka mini cover mini	mleczna frosted	PC
PA-OSTRGLAXM45M-00			transparentna transparent	
PA-ZASGLAXMNKW-00			szary gray	
PA-ZASGLAXMNKW-10			biały white	
PA-ZASGLAXMNKW-90	-	zaślepka end cap	szampan champagne	ABS
PA-ZASGLAXMNKW-20M			czarny mat black matt	
PA-SPRGLAXM-00	-	uchwyt mounting clip	srebrny silver	stal nierdzewna stainless steel

Profil GLAX wpuszczany, mikro / GLAX profile recessed, micro



PA-GLAXMIC-AL	2			
PA-GLAXMIC3M-AL	3	profil profile	srebrny silver	aluminium aluminium
PA-OSMLGLAXMIC-00N	2			
PA-OSMLGLAXMIC3M-00N	3	osłonka micro cover micro	mleczna frosted	PC
PA-OSMLGLAXMIC45M-00N	45			
PA-ZASGLAXMIC-00	-	zaślepka end cap	szary gray	ABS

Profil GLAX wpuszczany / Profile GLAX recessed

	 L mm			
PA-GLAX-AL	2	profil profile	srebrny silver	aluminium aluminium
PA-GLAX-AL-20M			czarny black	
PA-GLAX-AL-10			biały white	
PA-GLAX-AL-90			szampan champagne	
PA-GLAX3M-AL	3	profil profile	srebrny silver	aluminium aluminium
PA-GLAX3M-AL-20M			czarny black	
PA-GLAX3M-AL-10			biały white	
PA-OSMLGLAX-00	2	osłonka cover	mleczna frosted	PC
PA-OSMLGLAX3M-00	3		transparentna transparent	
PA-OSTRGLAX-00	2			
PA-OSTRGLAX3M-00	3			
PA-OSCLGLAX-00	2		czarny black	
PA-OSCLGLAX3M-00	3		czarny black	
PA-OSCLGLAX35M-00	35			
PA-OSMLGLAX35M-00				
PA-OSTRGLAX35M-00			transparentna transparent	

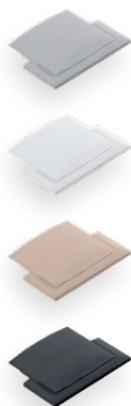

	 mm			
PA-ZASGLAX-00	-	zaślepka end cap	szary gray	ABS
PA-ZASGLAX-10			biały white	
PA-ZASGLAX-90			szampan champagne	
PA-ZASGLAX-20M			czarny mat black matt	

Profil GLAX wpuszczany wysoki / Profile GLAX recessed, high

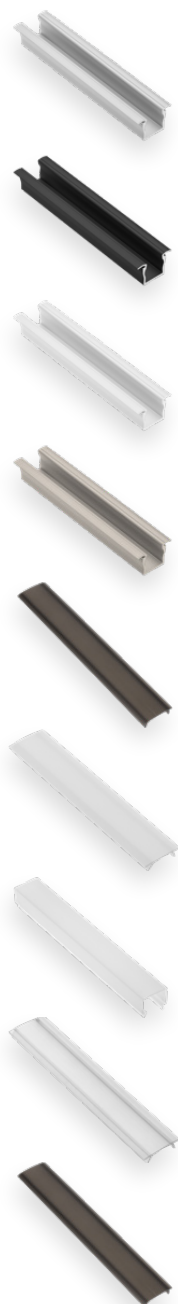

	 mm			
PA-GLAXMW-AL	2	profil profile	srebrny silver	aluminium aluminium
PA-GLAXMW-AL-20M			czarny black	
PA-GLAXMW-AL-10			biały white	
PA-GLAXMW-AL-90			szampan champagne	
PA-OSCLGLAXM-00	2	osłonka mini cover mini	czarny black	PC
PA-OSMLGLAXM-00	2		mleczna frosted	
PA-OSMLGLAXMK-00	2	osłonka kwadratowa, square covere		
PA-OSTRGLAXM-00	2	osłonka mini cover mini	transparentna transparent	PC
PA-OSCLGLAXM45M-00	45	osłonka mini cover mini	czarny black	PC



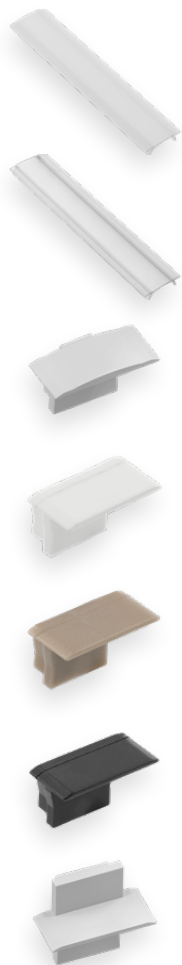

PA-OSMLGLAXM45M-00	45	osłonka mini cover mini	mleczna frosted	PC
PA-OSTRGLAXM45M-00	45	osłonka mini cover mini	transparentna transparent	PC
PA-ZASGLAXMW-00	-	zaślepka standard standard end cap	szary gray	ABS
PA-ZASGLAXMW-10			biały white	
PA-ZASGLAXMW-90			szampan champagne	
PA-ZASGLAXMW-20M			czarny mat black matt	
PA-ZASGLAXMWK-00	-	zaślepka kwadratowa square end cap	szary gray	

Profil GLAX wieńcowy / Rim profile GLAX

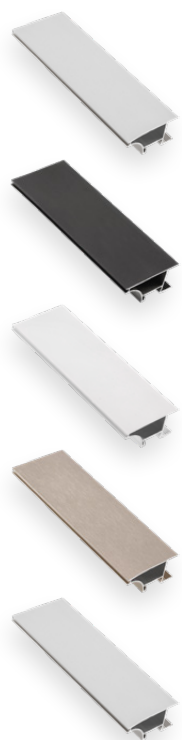



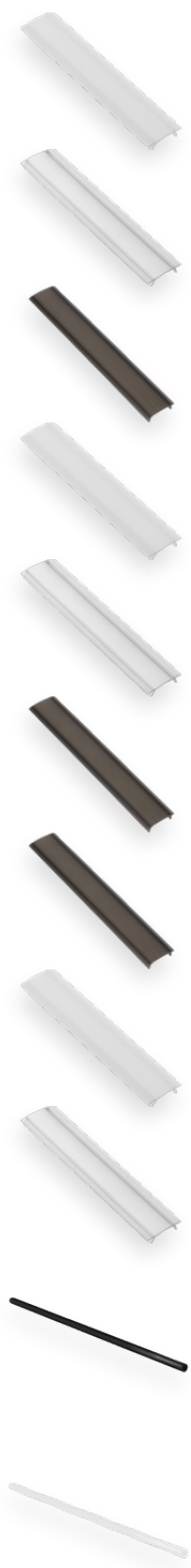

PA-GLAXWN-AL	18	2	profil profile	srebrny silver	aluminium aluminium
PA-GLAXWN3M-AL		3		czarny black	
PA-GLAXWN3M-AL-20M				biały white	
PA-GLAXWN3M-AL-10				stal szczerkowana brushed steel	
PA-GLAXWN3M-AL-06				2	
PA-GLAXWN16-AL		16			
PA-GLAXWN19-AL	19				



						
PA-OSMLGLAX-00					mleczna <i>frosted</i>	PC
PA-OSTRGLAX-00	-	2	osłonka <i>cover</i>	transparentna <i>transparent</i>		
PA-OSCLGLAX-00	-			czarny <i>black</i>		
PA-OSMLGLAX3M-00					mleczna <i>frosted</i>	PC
PA-OSTRGLAX3M-00	-	3	osłonka <i>cover</i>	transparentna <i>transparent</i>		
PA-OSCLGLAX3M-00	-			czarny <i>black</i>		
PA-OSCLGLAX35M-00					czarny <i>black</i>	PC
PA-OSMLGLAX35M-00	-	35	osłonka <i>cover</i>	mleczna <i>frosted</i>		
PA-OSTRGLAX35M-00	-			transparentna <i>transparent</i>		
PA-USZGLAX-00N					czarny <i>black</i>	EPDM
PA-USZGLAX-10N	-	10	uszczelka <i>cord gasket</i>	biały <i>white</i>		

Profil GLAX kątowy, nakładany / GLAX aluminium corner profile – surface mounted

	 L mm				
PA-GLAXNKKT-AL	2	profil profile	srebrny silver	aluminium aluminium	
PA-GLAXNKKT-AL-20M			czarny black		
PA-GLAXNKKT-AL-10			biały white		
PA-GLAXNKKT-AL-90			szampan champagne		
PA-GLAXNKKT3M-AL	3	profil profile	srebrny silver	aluminium aluminium	
PA-GLAXNKKT3M-AL-20M			czarny black		
PA-GLAXNKKT3M-AL-10			biały white		
PA-OSMLGLAX-00	2	osłonka cover	mleczna frosted	PC	
PA-OSMLGLAX3M-00	3		transparentna transparent		
PA-OSTRGLAX-00	2				
PA-OSTRGLAX3M-00	3		czarny black		
PA-OSCLGLAX-00	2				
PA-OSCLGLAX3M-00	3		czarny black		
PA-OSCLGLAX35M-00	35				mleczna frosted
PA-OSMLGLAX35M-00					
PA-OSTRGLAX35M-00					

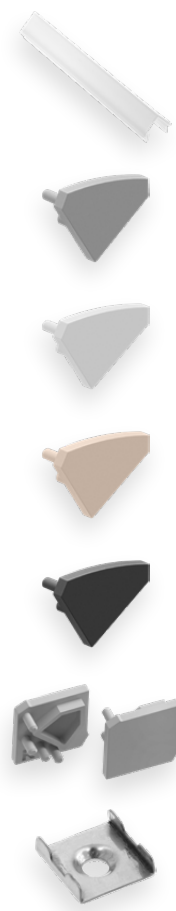



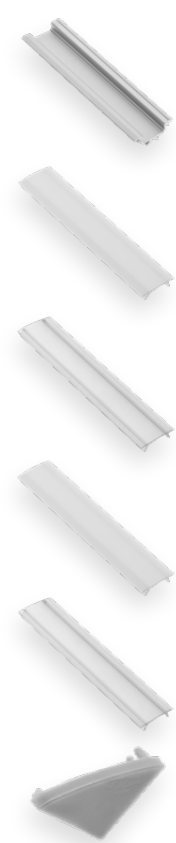

	 mm			
PA-OSMLGLAXT-00	2	osłonka trójkątna <i>triangular cover</i>	mleczna <i>frosted</i>	PC
PA-OSMLGLAXT3M-00	3			
PA-ZASGLAXNKKT-00	-	zaślepka trójkątna <i>end cap triangular</i>	szary <i>gray</i>	ABS
PA-ZASGLAXNKKT-10			biały <i>white</i>	
PA-ZASGLAXNKKT-90			szampan <i>champagne</i>	
PA-ZASGLAXNKKT-20M			czarny mat <i>black matt</i>	
PA-ZASGLAXNKKT-00		zaślepka standard <i>end cap standard</i>	szary <i>gray</i>	
PA-SPRGLAXMIC-00	-	uchwyt <i>mounting clip</i>	srebrny <i>silver</i>	stal nierdzewna <i>stainless steel</i>

Profil GLAX kątowy / *GLAX corner profile*





	 mm			
PA-GLAXKT-AL	2	profil <i>profile</i>	srebrny <i>silver</i>	aluminium <i>aluminium</i>
PA-GLAXKT3M-AL	3			
PA-OSMLGLAX-00	2	osłonka <i>cover</i>	mleczna <i>frosted</i>	PC
PA-OSMLGLAX3M-00	3			
PA-OSTRGLAX-00	2		transparentna <i>transparent</i>	
PA-OSTRGLAX3M-00	3			
PA-OSMLGLAX35M-00	35	osłonka <i>cover</i>	mleczna <i>frosted</i>	PC
PA-OSTRGLAX35M-00			transparentna <i>transparent</i>	
PA-ZASGLAXKT-00	-	zaślepka <i>end cap</i>	szary <i>gray</i>	ABS

Profil GLAX kątowy wpuszczany / Recessed corner profile GLAX

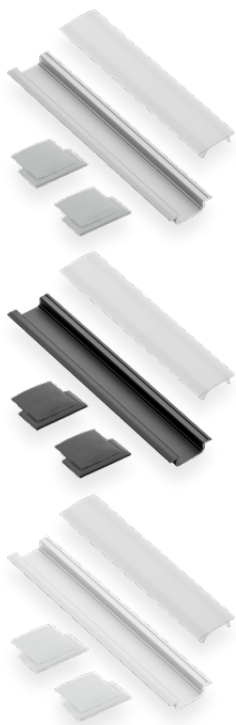



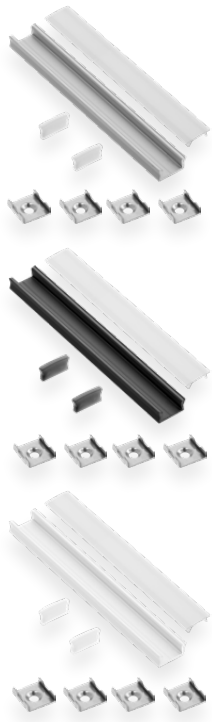

				
PA-GLAXWPKT-AL		profil profile	srebrny silver	aluminium aluminium
PA-OSMLGLAX-00	2	osłonka cover	mleczna frosted	PC
PA-OSTRGLAX-00			transparentna transparent	
PA-OSMLGLAX35M-00	35		mleczna frosted	
PA-OSTRGLAX35M-00			transparentna transparent	

Zestaw GLAX wpuszczany / GLAX recessed - kit

				
PA-ZGLAXOMZ-00	2	zestaw kit	srebrny silver	aluminium aluminium
PA-ZGLAXOMZ-20M	2	zestaw kit	czarny black	aluminium aluminium
PA-ZGLAXOMZ-10	2	zestaw kit	biały white	aluminium aluminium

Zestaw GLAX nakładany mini / GLAX profile mini surface mounted - kit



	 mm			
PA-ZGLAXMNKOMZ-00	2	zestaw kit	srebrny silver	aluminium, PC mleczne, ABS aluminium, PC frosted, ABS
PA-ZGLAXMNKOMZ-20M	2	zestaw kit	czarny black	
PA-ZGLAXMNKOMZ-10	2	zestaw kit	biały white	

Zestaw GLAX kątowy, nakładany / GLAX aluminium corner profile – surface mounted – kit



	 mm			
PA-ZGLAXNKKTOMZ-20M	2	zestaw kit	czarny black	aluminium, PC mleczne, ABS aluminium, PC frosted, ABS
PA-ZGLAXNKKTOMZ-10	2	zestaw kit	biały white	

TAŚMY LED / LED STRIP

Taśma LED FLASH / LED strip FLASH



LD-2835-600-5MM-20-ZB	12 VDC 14,4 W/1 m 44 W/5 m	750 lm/m	● 6500 K	20	120	5	120/m	2,5
LD-2835-600-5MM-20-NE4			● 4000 K	20	120			
LD-2835-600-5MM-20-CB			● 3200 K	20	120			

Taśma LED COB / LED strip COB



LD-COB12V-20-ZBN	12 V DC 8 W/1 m	600 lm/m	● 6500 K	20	180	8	320/m	2,5
LD-COB12V-20-CBN		600 lm/m	● 2700 K	20	180	8		
LD-COB12V-20-NEN		700 lm/m	● 4000 K	20	180	8		
LD-COB12V-20-ZBPQ	12 V DC 10 W/1 m	800 lm/m	● 6500 K	20	180	8	480/m	2,5
LD-COB12V-20-CBPQ		750 lm/m	● 2700 K	20	180	8		
LD-COB12V-20-NEPQ		800 lm/m	● 4000 K	20	180	8		
LD-COB24V-20-ZBN	24 V DC 8 W/1 m	650 lm/W	● 6500 K	20	1800	8	320/m	2,5
LD-COB24V-20-CBN			● 2700 K	20	1800	8		
LD-COB24V-20-NEN			● 4000 K	20	1800	8		
LD-COB24V-20-ZBPQ	24 VDC 9,6 W /1 m 34 W /5 m	950 lm/m	● 6500 K	20	1800	8	480/m	2,5
LD-COB24V-20-CBPQ			● 2700 K	20	1800	8		
LD-COB24V-20-NEPQ			● 4000 K	20	1800	8		

Taśma LED COB FREE CUT / LED strip COB FREE CUT



LD-COBFC12V-528-20-CB	12 V DC 11 W/1 m	740 lm/W	● 2700 K	20	1800	8	528/m	free cut
LD-COBFC12V-528-20-NE	12 V DC 11 W/1 m		● 4000 K	20	1800	8		
LD-COBFC12V-528-20-ZB	12 V DC 11 W/1 m		● 6500 K	20	1800	8		

Taśma LED FLASH / LED strip FLASH



LD-COBFC24V-528-20-CB	24 V DC 11 W/1 m	480 lm/W	● 2700 K	20	180	8	528/m	free cut
LD-COBFC24V-528-20-NE			● 4000 K	20	180			
LD-COBFC24V-528-20-ZB			● 6500 K	20	180			

Taśma LED FLASH / LED strip FLASH



LD-COBST12V-480-65-CB	12 V DC 12 W/m	812 lm/m	● 2700 K	20	180	8	528/m	2,5
LD-COBST12V-480-65-NE			● 4000 K	20	180			
LD-COBST12V-480-65-ZB			● 6500 K	20	180			

Taśma LED FLASH / LED strip FLASH



LD-COBST24V-480-65-CB	24 V DC 11 W/m	828 lm/m	● 2700 K	20	180	8	528/m	2,5
LD-COBST24V-480-65-NE			● 4000 K	20	180			
LD-COBST24V-480-65-ZB			● 6500 K	20	180			

ZASILACZE / POWER SUPPLY

Zasilacz LED EASY CLICK / LED power supply EASY CLICK



				Wymiary Dimensions		
LD-ZAS09WEC-30	9 W	3 miniAMP	0,75 A	103 × 41 × 12 mm	tworzywo plastic	110 g
LD-ZAS15WEC-30	15 W		1,25 A	129 × 42 × 16 mm	tworzywo plastic	130 g
LD-ZAS20WEC-30	20 W		1,67 A	129 × 42 × 16 mm	tworzywo plastic	140 g
LD-ZAS30WEC-30	30 W	6 miniAMP	2,5 A	160 × 50 × 18 mm	tworzywo plastic	190 g
LD-ZAS60WEC-30	60 W		5 A	190 × 62 × 21 mm	tworzywo plastic	290 g
LD-ZAS100WEC-30	100 W		8,33 A	190 × 62 × 21 mm	tworzywo plastic	300 g

Zasilacz LED EASY CLICK / LED power supply EASY CLICK

				Wymiary Dimensions		
LD-ZAS09WEC24-30	9 W	3 miniAMP	0,375 A	103 × 41 × 12 mm	tworzywo plastic	140 g
LD-ZAS15WEC24-30	15 W	4 miniAMP	0,625 A	129 × 42 × 16 mm	tworzywo plastic	160 g
LD-ZAS20WEC24-30	20 W		0,83 A	129 × 42 × 16 mm	tworzywo plastic	170 g
LD-ZAS30WEC24-30	30 W	6 miniAMP	1,25 A	160 × 50 × 18 mm	tworzywo plastic	220 g
LD-ZAS60WEC24-30	60 W		2,5 A	190 × 62 × 21 mm	tworzywo plastic	320 g
LD-ZAS100WEC24-30	100 W		4,17 A	190 × 62 × 21 mm	tworzywo plastic	300 g

Zasilacz LED PRO+ / LED power supply PRO+

		PF 		Wymiary Dimensions		
LD-ZASPROPLUS06W-30	6 W	>0,7	0,5 A	90 × 40 × 24 mm	tworzywo plastic	60 g
LD-ZASPROPLUS12W-30	12 W	>0,9	1 A	90 × 40 × 24 mm	tworzywo plastic	60 g
LD-ZASPROPLUS15W-30	15 W		1,25 A	90 × 40 × 24 mm	tworzywo plastic	65 g
LD-ZASPROPLUS20W-30	20 W		1,66 A	120 × 42 × 20 mm	tworzywo plastic	85 g
LD-ZASPROPLUS36W-30	36 W		3 A	147 × 48 × 24 mm	tworzywo plastic	120 g
LD-ZASPROPLUS50W-30	50 W		4,16 A	185 × 65 × 22 mm	tworzywo plastic	200 g
LD-ZASPROPLUS60W-30	60 W		5 A	185 × 65 × 22 mm	tworzywo plastic	200 g
LD-ZASPROPLUS80W-30	80 W		6,66 A	170 × 57 × 32 mm	tworzywo plastic	400 g
LD-ZASPROPLUS100W-30	100 W		8,33 A	180 × 66 × 32 mm	tworzywo plastic	305 g
LD-ZASPROPLUS150W-30	150 W	12,5 A	205 × 71 × 35 mm	tworzywo plastic	540 g	

Zasilacz LED PRO+ / LED power supply PRO+



				Wymiary Dimensions			
LD-ZAS24PROPLUS06W-30	6 W	>0,7	0,25 A	90 × 40 × 24 mm	tworzywo plastic	60 g	
LD-ZAS24PROPLUS12W-30	12 W		0,5 A	90 × 40 × 24 mm	tworzywo plastic	60 g	
LD-ZAS24PROPLUS15W-30	15 W		0,625 A	90 × 40 × 24 mm	tworzywo plastic	65 g	
LD-ZAS24PROPLUS20W-30	20 W		0,83 A	120 × 42 × 20 mm	tworzywo plastic	85 g	
LD-ZAS24PROPLUS36W-30	36 W		1,5 A	147 × 48 × 24 mm	tworzywo plastic	120 g	
LD-ZAS24PROPLUS50W-30	50 W		>0,9	2,08 A	185 × 65 × 22 mm	tworzywo plastic	200 g
LD-ZAS24PROPLUS60W-30	60 W		2,5 A	185 × 65 × 22 mm	tworzywo plastic	200 g	
LD-ZAS24PROPLUS80W-30	80 W		3,3 A	170 × 57 × 32 mm	tworzywo plastic	400 g	
LD-ZAS24PROPLUS100W-30	100 W	4,16 A	180 × 66 × 32 mm	tworzywo plastic	305 g		
LD-ZAS24PROPLUS150W-30	150 W	6,25 A	205 × 71 × 35 mm	tworzywo plastic	540 g		

WŁĄCZNIKI / SWITCHES

Włącznik dotykowy bezprzewodowy on-off / Wireless touchless switch on-off

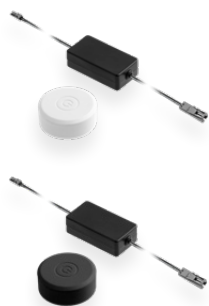

AE-WDBP1-10NN	biały white	tworzywo plastic
AE-WDBP1-20NN	czarny black	tworzywo plastic

Włącznik bezdotykowy uniwersalny 3 w 1

/ 3 in 1 all-purpose touchless switch



AE-WBBUNI-10DIM	biały white	tworzywo plastic
AE-WBCUNI-10DIM	czarny black	tworzywo plastic

Włącznik dotykowy ściemniający / Dimmable touch switch

AE-WBEZD-NB	chrom chrome	tworzywo plastic

Włącznik dotykowy ściemniający RING / Dimmable touch switch RING

AE-WDRIN-20	12V/24V	3 A	tworzywo plastic

Włącznik dotykowy krawędziowy BORD / Dimmable touch switch BORD

AE-WDKBOR-53	12V/24V	3 A	tworzywo plastic

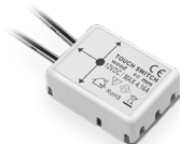
Włącznik podblatowy / Countertop switch

AE-WPDRW-00	biały white	tworzywo plastic

Włącznik bezdotykowy ściemniający do profili LED z konektorem COB / Touchless dimmable switch for LED profiles with COB connector

AE-WLPRKON-60	12 V/24 A	5 A	tworzywo plastic
AE-WLPRKON-60P15		3 A	tworzywo plastic
AE-WLPRKON-60P200		3 A	tworzywo plastic

Włącznik bezdotykowy do profili LED / Touchless switch for led profiles

AE-WLPR-60	-	biały white	tworzywo plastic
AE-WLPR-60P2	2 m		

GTV

ul. Przejazdowa 21
05-800 Pruszków
Poland

tel.: + 48 22 444 75 00
fax: +48 22 444 75 03
e-mail: info@gtv.com.pl

Follow us on

