



Over 80 years of experience

in Hardware, DIY and Industrial Supplies

Since our company was founded in **1.940**, at AMIG we have grown and evolved steadily by taking into account market needs and demand. In more than 80 years of business, we have provided solutions for customers in the hardware, security, industrial supplies, DIY and gardening sectors, among many others, and have built up a sales network with over **10,000 points of sale** in more than **90 countries**.

We are also committed to quality. **Our Quality and R&D departments** are staffed by highly qualified personnel who strive to attain total quality and work on the design and manufacture of many of our products.

The **AMIG** product catalogue currently contains **over 15,000 items, sorted into the following families**: locksmithery, hardware & fittings, gardening, household goods, electricity and professional items.

Plus de 80 années d'expérience

en quincaillerie, sécurité, bricolage et fournitures industrielles

Depuis la création d'AMIG en **1940**, nous n'avons eu une croissance et progression constante tout en suivant les besoins et les demandes du marché. Au cours de plus de 80 ans d'activité, nous avons apporté à nos clients des solutions aux besoins du secteurs comme, entre autres, la quincaillerie, la sécurité, les fournitures industrielles, le bricolage ou le jardinage ; nous avons déployé un réseau commercial comptant aujourd'hui plus de **10 000 points de vente** dans plus de **90 pays**.

Nous nous engageons à fournir de la qualité. **Nos départements de qualité et recherche & développement** sont composé par personnes qualifiés dont la mission est de garantir la qualité totale dans le design et la fabrication d'un grand nombre de nos produits.

Le catalogue de produits d'AMIG propose à ce jour **plus de 15 000 références organisées par familles**: serrurerie, quincaillerie et ferrures, jardinage, articles pour la maison, électricité et ligne professionnelle.

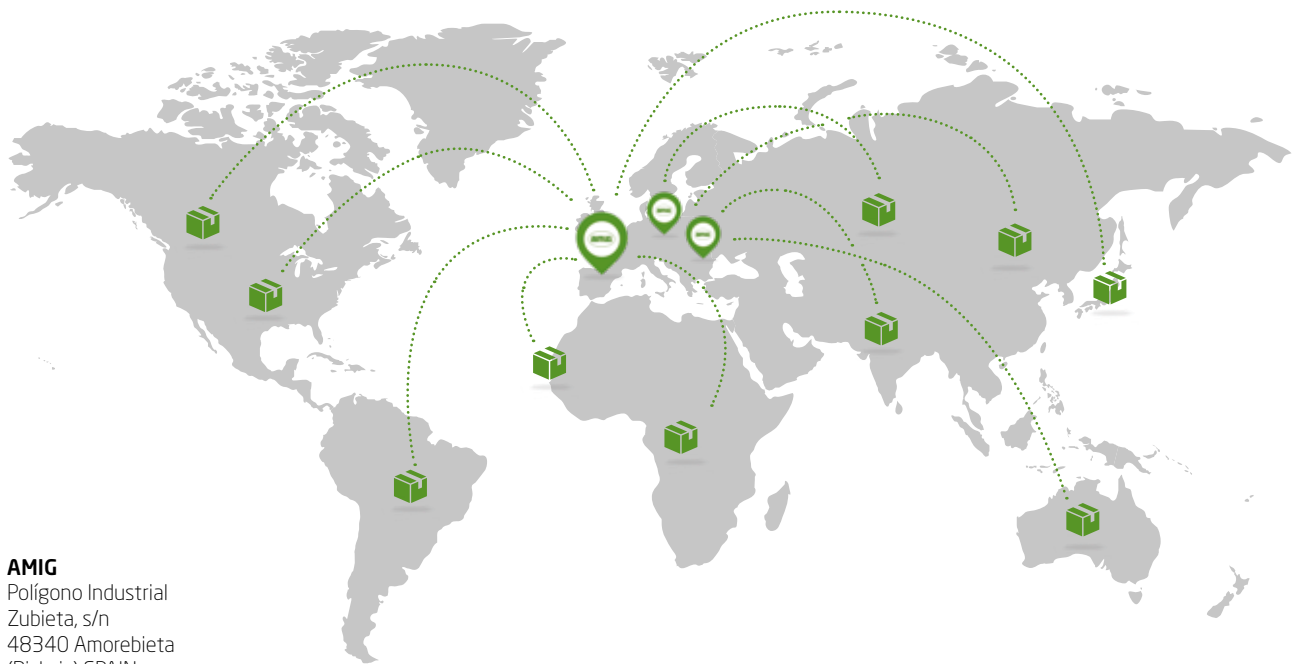

AMIG
Polígono Industrial
Zubieta, s/n
48340 Amorebieta
(Bizkaia) SPAIN



SERVICE RATE
TAUX DE SERVICE



RESEARCH & DEVELOPMENT
R+D RECHERCHE & DÉVELOPPEMENT



ALWAYS NON-STOP STOCK
TOUJOURS DU STOCK NON-STOP



B2B SOLUTIONS
SOLUTIONS B2B



R&D, CONTINUOUS GROWTH
R&D, CROISSANCE CONTINUE



AMIG, A HUMAN TEAM
AMIG, UNE ÉQUIPE HUMAINE

- > Uninterrupted supply.
- > Permanent stock of our more than 14,000 references.
- > Product availability rate over 98%.
- > *Approvisionnement sans faille.*
- > *Stock permanent de plus de 14.000 références.*
- > *Taux de disponibilité des produits supérieur à 98%.*

- > What you need when you need it.
- > We SPEED UP the online inquiries of stocks, orders, invoicing...
- > We INFORM about all our product innovations.
- > *Ce dont vous avez besoin quand vous en avez besoin.*
- > *Nous FACILITONS la consultation en ligne des stocks, commandes, facturations...*
- > *Nous INFORMONS sur toutes nos nouveautés de produits.*

- > Our own technology incorporated into our most technical products.
- > Product development focused on client needs.
- > *Technologie propre intégrée aux plus techniques.*
- > *Développement de produits axé sur les besoins des clients.*

- > AMIG, a human team at the service of people.
- > National and international distribution network with 3 headquarters in Europe and our own network of commercial teams with more than 10,000 sales points.
- > *AMIG, une équipe humaine au service des personnes.*
- > *Réseau national et international de distribution avec 3 sièges en Europe et un réseau propre d'équipes commerciales avec plus de 10.000 points de vente.*

www.amig.es

Making things easy for our customers

Simplicité pour nos clients



At AMIG we are making major efforts to digitize all our processes, based on our B2B system as the main pillar of this initiative. We provide all our customers with a customized account for accessing our B2B system, which enables them to make queries and carry out several tasks quickly and efficiently.

Chez AMIG, nous faisons d'importants efforts pour numériser tous nos processus, en nous basant sur notre système B2B comme pilier principal de cette initiative. Nous fournissons à tous nos clients un compte personnalisé pour accéder à notre système B2B, ce qui leur permet de faire des requêtes et d'effectuer plusieurs tâches rapidement et efficacement.

	SECURITY SÉCURITÉ			5
	DOOR AND WINDOW ACCESSORIES ACCESSOIRES POUR PORTES ET FENÊTRES			8
	BARREL BOLTS VERROUX ET TARGETTES			15
	RUSTIC FITTINGS FERRURES RUSTIQUES			17
	HINGES CHARNIÈRES ET PAUMELLES			25
	SUPPORTS SUPPORTS			29
	TABLE LEGS & CASTORS PIEDS ET ROUES			34
	FURNITURE FITTINGS QUINCAILLERIE DU MEUBLE			36
	PROFILES AND METAL SHEETS PROFILS ET TÔLES DÉCORATIVES			37
	HARDWARE-HOME QUINCAILLERIE-MAISON			39
	POINT OF SALE POINT DE VENTE			40



SECURITY SÉCURITÉ



HIGH SECURITY BOLT LOCK MOD. 1PLUS VERROU HAUTE SÉCURITÉ MOD. 1PLUS

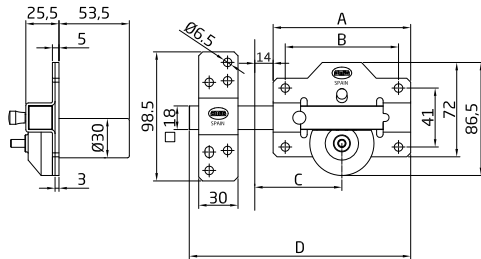

Mod.	A (mm)	B (mm)	C (mm)	D (mm)
90	90	63.5	59	154

Sizes Mesures

Cod.



90 x 154 mm

24954

1 ud.

1

10

Features:

- > Flush mount bolt lock with round high security cylinder and opening latch.
- > Cylinder length 50 mm.
- > 6 pin cylinder with SS springs.
- > Pickproof.
- > Antidrillig plate.
- > High resistance to extraction and breakage.
- > Antibumping.
- > Includes property card and 5 coded security flat keys.
- > Key blank model 10080.

Caractéristiques:

- > Verrou de superposition avec cylindre rond de haute sécurité et loquet d'ouverture.
- > Longueur du cylindre: 50 mm.
- > Cylindre à 6 goupilles et ressorts en acier inox.
- > Plaque avec protection anti-perçage.
- > Haute résistance à l'extraction et à la rupture.
- > Système anti-bumping.
- > Avec une carte de propriété et 5 clés de points codées.
- > Ebauche de clé modèle 10080.



SECURITY BOLT LOCK MOD. 1 VERROU DE SÉCURITÉ MOD. 1

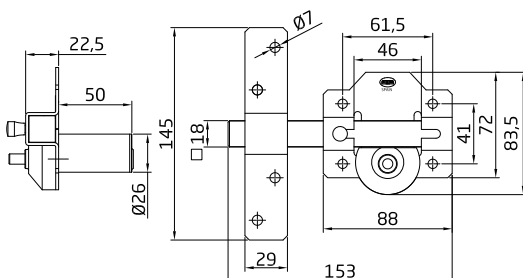

Sizes Mesures

Cod.



88 x 153 mm

24953



1

10

Features:

- > Surface-mounted bolt lock with round security cylinder and latch lock opening button.
- > Cylinder length: 50 mm.
- > Includes 5 drilled keys.
- > Model 2500 key blank.

Caractéristiques:

- > Serrure à superposer avec cylindre arrondi de sécurité et pêne d'ouverture.
- > Longueur du cylindre: 50 mm.
- > Avec 5 clés à points.
- > Clé en brut modèle 2500.

KEYHOLE MOD. 22
ROSACE DE CLÉ MOD. 22



Sizes Mesures	Cod.		
Ø58 mm	13472		20 100

ESCUTCHEON MOD. 35
PROTECTEUR DE CYLINDRE MOD. 35



Sizes Mesures	Cod.		
70 x 25 mm	21165		4 120

ESCUTCHEON MOD. 3700
PROTECTEUR DE CYLINDRE MOD. 3700



Sizes Mesures	Cod.		
70 x 29 mm	22048		10 120
	22050		5 30

ESCUTCHEON MOD. 31 **PROTECTEUR DE CYLINDRE MOD. 31**



Sizes Mesures	Cod.		
Ø65 mm	20094		1 30

DOOR LATCH SERRURE BEC DE CANNE



MOD. 6



MOD. 7



MOD. 8



MOD. 12

35 mm	10782				24947			
45 mm	10785	24309			10794 (A)			
					15984 (B)	24315 (B)	10801	24317
60 mm			10788	24311			10805	24319
70 mm			10791	24313			24321	

LATCH LOCK SERRURE BEC DE CANNE À CONDAMNATION



MOD. 2000



MOD. 2001

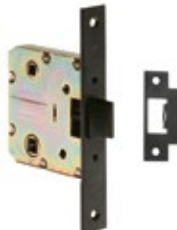

MOD. 2100



MOD. 4000



MOD. 4001



MOD. 4100

50/47 mm	4990	12597	4991	6271	17217	6277
----------	-------------	--------------	-------------	-------------	--------------	-------------



CYLINDERS CYLINDRES



MOD. 9400BG



MOD. 9850



MOD. 9850 WITH HANDLE / À BOUTON



60 (30-30)	24573	20095	23570
70 (30-40)	24574	20097	
70 (35-35)		20096	23571



MOD. AS010



MOD. AS010



60 (30-30)	27266
70 (35-35)	27267

60 (30-30M)	27268
70 (35-35M)	27269

DOOR LOCK SERRURE



MOD. 100



MOD. 101



MOD. 110



MOD. 111



MOD. 120



50/85	18456	18457	21633	21638	21635
60/85	21632	21637			
50/85 BASE	21636	21639			

DOOR LOCK SERRURE



MOD. 330



MOD. 331



MOD. 332



MOD. 340



MOD. 341



50/47	14939	14941	24575	8293	8298
50/70					
50/85				8293	8298
50/85 BASE				23979	

DOOR LOCK SERRURE



MOD. 605



MOD. 606



MOD. 500



MOD. 1102

NEW



50 mm

24014

24016

24020

24957



SECURITY LOCK FOR SLIDING WINDOW MOD. 40
VERROU DE SÉCURITÉ POUR FENÊTRES COULISSANTES MOD. 40



Sizes Mesures	Cod.		
Ø30 x 152 mm	21686		10
	21689	1 ud.	6

SLIDING WINDOW LOCK MOD. 45
SERRURE DE FENÊTRE COULISSANTE MOD. 45



Sizes Mesures	Cod.		
53 x 23 mm	21692		10
	21695	1 ud.	6

DOOR AND WINDOW
ACCESSORIES
ACCESSOIRES POUR PORTES ET
FENÊTRES



DOOR VIEWER JUDAS OPTIQUE



MOD. 2



MOD. 3



MOD. 4



MOD. 5



MOD. 7

Ø14 15-25 mm			9970	19980		
Ø14 25-42 mm	9968	19978				
Ø14 35-60 mm			9969			
Ø16 60-85 mm					9971	
Ø16 35-60 mm						9972

DOORSTOP BUTOIR DE PORTE



MOD. 205



MOD. 206



MOD. 404



MOD. 405



Ø30 mm x 37 mm	23840	23842			
Ø30 mm x 48 mm			23841	23843	
Ø40 x 27 x 108 mm					18911 18812
45 x 45 mm					18919



MOD. 100



MOD. 201



MOD. 202



Ø20 mm		25151	
Ø28 mm			25152
Ø45 mm	25164		



NEW

MOD. 700



NEW

MOD. 702



MOD. 710



NEW

MOD. 715

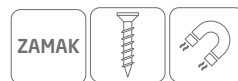
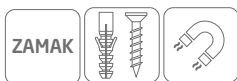

36 x 38 x 41 mm		25166	
44 x 40 mm	25165		
Ø45 x 75 mm			22720
Ø55 x 85 mm			25167

DOOR RETAINERS BLOQUE-PORTE



MOD. 10



MOD. 11



MOD. 1

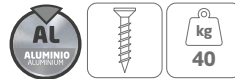

108 x 32 mm				22501
120 x 25 mm	6468	17584		
165 x 30 mm			6891	



DOOR OPENER MOD. 1 PÉDALE PORTES MOD. 1



Sizes Mesures	Cod.		
147 x 98 x 3 mm	23957	1	24

DRAUGHT EXCLUDER
PLINTE ÉTANCHE

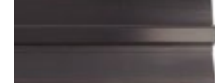

MOD. 2

MOD. 3

MOD. 4

MOD. 5

MOD. 7



820 mm	10422	10424			
1000 mm	10423	10425	22554	22559	23970

VENTILATION GRILLE MOD. 3
GRILLE D'AÉRATION MOD. 3



VENTILATION GRILLE WITH MOSQUITO NET MOD. 3
GRILLE D'AÉRATION AVEC MOUSTIQUAIRE MOD. 3



Sizes Mesures	Cod.		
100 x 100 mm	25126	1 ud.	10 200
100 x 200 mm	25127	1 ud.	10 200
150 x 150 mm	25128	1 ud.	10 200
150 x 300 mm	25129	1 ud.	10 200
170 x 170 mm	25130	1 ud.	10 200
200 x 200 mm	25131	1 ud.	10 200
250 x 250 mm	25132	1 ud.	10 100

Sizes Mesures	Cod.		
100 x 200 mm	25133	1 ud.	10 200
150 x 150 mm	25134	1 ud.	10 200
150 x 300 mm	25135	1 ud.	10 160
170 x 170 mm	25136	1 ud.	10 180
200 x 200 mm	25137	1 ud.	10 150
250 x 250 mm	25138	1 ud.	10 100
300 x 300 mm	25139	1 ud.	5 35



DOOR CLOSER FERME-PORTE



MOD. 3000

MOD. 4000

MOD. 5000

MOD. 777

MOD. 799



Power 3 Force 3	5639					
Power 4 Force 4		5640				
Power 2/3/4 Force 2/3/4			19966	10511	20318	20469

TRACK ARM MOD. 6500 BRAS COULISSANT MOD. 6500



Cod.			
5638		1	10

TRACK ARM MOD. 3000 4000 BRAS STANDARD MOD. 3000 4000



Cod.			
24660		1	10



HANDLE MOD. 735 BÉQUILLE MOD. 735



Cod.			
24077		1	12

HANDLE MOD. 737 BÉQUILLE MOD. 737



Cod.			
24079		1	12

KNOB BOUTON



MOD. 610



12303



MOD. 611



12305



MOD. 612



12307

CENTRE DOOR KNOB MOD. 56 BOUTON DE PORTE D'ENTRÉE MOD. 56



Sizes Mesures	Cod.		
Ø70 mm	24643		1 50
	24646	1 ud.	2 36

ALUMINIUM DOOR KNOB MOD. 6807 BOUTON DE PORTE ALUMINIUM MOD. 6807



Sizes Mesures	Cod.		
81 x 31 mm	22040		1 12
	22042	1 ud.	2 12

PULL HANDLE MOD. 3040 POIGNÉE DE TIRAGE MOD. 3040



Sizes Mesures	Cod.		
198 x 25 mm	22081		4 40
	22084	1 ud.	2 20

ALUMINIUM PULL HANDLE MOD. 3050 POIGNÉE DE TIRAGE EN ALUMINIUM MOD. 3050



Sizes Mesures	Cod.		
185 mm	22044		2 24
	22046	1 ud.	2 24

ALUMINIUM HANDLE ENSEMBLE SUR PLAQUE BDC ALUMINIUM



MOD. 1500ALPB85



MOD. AL3P



MOD. AL4P

225 x 30 mm	22036	22038	
222 x 55 mm			12612
			12615



HANDLE BÉQUILLE



MOD. 3P



MOD. 3PB72



MOD. 3PB72



172 x 46 mm

21282

21283

21284



MOD. 3PX



MOD. 3PXB85



MOD. 4PX



MOD. 4PXB85



245 x 45 mm

24648

24649

24650

24651

24652

24653

24654

24655

HANDLE WITH ROSETTE + KEY HOLE POIGNÉES SUR ROSACE + ROSACE



MOD. BOLONIA



MOD. CADIZ



MOD. ROCHE



MOD. ZAHORA

ZAMAK

ZAMAK

ZAMAK

ZAMAK



51 x 51 mm

23837

23658

23839

23659

24999

HANDLE BÉQUILLE



MOD. 3RX



MOD. 4RX



MOD. SUKI



MOD. 8RX

Ø52 mm

23883

24034

Ø53 mm

23882

24033

54 x 54 mm

24032

23884

HANDLE MOD. SENDOA BÉQUILLE MOD. SENDOA



Sizes Mesures		Cod.			
125 x 66 mm	Set Jeu	24582		1	20
		24586	1 ud.	4	24
	Piece Demie	24584		1	20
		24588	1 ud.	4	24

HANDLE MOD. EPSILON-SP BÉQUILLE MOD. EPSILON-SP



Cod.			
24848	1 ud.	1	36

**WINDOW ALUMINIUM HANDLE MOD. GAMMA
BÉQUILLE POUR CRÉMONE EN ALUMINIUM MOD. GAMMA**



Sizes Mesures		Cod.			
122 x 70 mm	Right Droite	19511		1	20
		20251	1 ud.	4	24
	Left Gauche	19512		1	20
		20252	1 ud.	4	24

**ALUMINIUM DOOR HANDLE MOD. DELTA
POIGNÉES DE PORTE EN ALUMINIUM MOD. DELTA**



Sizes Mesures		Cod.			
121 x 72 mm	Set Jeu	19237		1	20
		20241	1 ud.	4	24
	Piece Demie	20420		1	20
		20417	1 ud.	4	24

**ALUMINIUM DOOR HANDLE MOD. EPSILON
POIGNÉES DE PORTE EN ALUMINIUM MOD. EPSILON**



Sizes Mesures		Cod.			
132 x 70 mm	Set Jeu	19246		1	20
		20244	1 ud.	4	24
	Piece Demie	19249		1	20
		20247	1 ud.	4	24

ALUMINIUM DOOR HANDLE MOD. 2115 POIGNÉES DE PORTE EN ALUMINIUM MOD. 2115



Sizes Mesures		Cod.			
105 x 40 mm	Thickness: 35 - 45 mm Épaisseur: 35 - 45 mm	21327	1 ud.	6	24
	Thickness: 45 - 55 mm Épaisseur: 45 - 55 mm	21328	1 ud.	6	24
	Thickness: 55 - 70 mm Épaisseur: 55 - 70 mm	23740	1 ud.	6	24



DEADBOLT HANDLE ROSACE DE CONDAMNATION



MOD. 9RX

MOD. 10RX

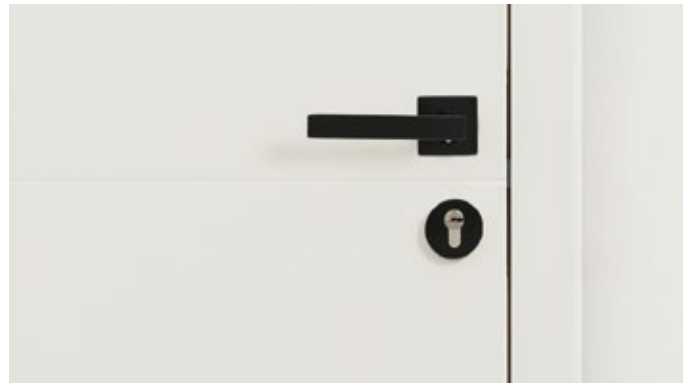

Ø53 mm	23889	
53 x 53 mm		23890

KEYHOLE ROSACE DE CLÉ



MOD. 3RX

MOD. 4RX

MOD. 5RX

MOD. 6RX

MOD. 6RX

Ø53 mm	23885	23886			
54 x 54 mm			23887	23888	
59 x 28 mm					24783 24786

ALUMINIUM DOOR HANDLE MOD. 2600V POIGNÉES DE PORTE EN ALUMINIUM MOD. 2600V



Sizes Mesures	Cod.		
172 x 27 mm	22064		2 24
	22066	1 ud.	2 12

ALUMINIUM DOOR HANDLE MOD. 2800V OSC POIGNÉES DE PORTE EN ALUMINIUM MOD. 2800V OSC



Sizes Mesures	Cod.		
180 x 35 mm	22072		2 24

ALUMINIUM DOOR HANDLE MOD. 2800V PR POIGNÉES DE PORTE EN ALUMINIUM MOD. 2800V PR



Sizes Mesures	Cod.		
180 x 35 mm	22068		2 24
	22070	1 ud.	2 12

SLIDING WINDOW LOCK FERMETURE À ENCASTRER



MOD. 3600

MOD. 3650

MOD. 3700

MOD. 3800

MOD. 3850

169 x 23 mm			22657	22673	
174 x 23 mm	22653	22669	22655	22671	
174 x 29 mm				22659	22675
192 x 28 mm					22661 22677

BARREL BOLTS VERROUX ET TARGETTES



BARREL BOLT VERROU



MOD. 384



MOD. 454



MOD. 500



40 mm	235		
50 mm	241		869
60 mm	244		870
70 mm	247	22351	
80 mm			871
85 mm	250	22352	
100 mm	253	22353	893
120 mm		22354	
150 mm			895
200 mm			896
250 mm			897
300 mm			898



MOD. 310



MOD. 410



MOD. 411



150 mm	4605	2428		6108	23407
200 mm				6109	23408
250 mm			6103	23405	6110
300 mm			6104	23406	
400 mm			6105		
500 mm			6106		
600 mm			6107		
300 mm				6111	23410



MOD. 1401 **MOD. 401**

150 mm	12281	12277
200 mm		12278
250 mm		12279
300 mm		12280



MOD. 420 **MOD. 421**

200 mm	21009	
250 mm	21010	
300 mm		21011
350 mm		21012
400 mm		21013



MOD. 320 **MOD. 340** **MOD. 484** **MOD. 584**

30 mm			6521	23411	
40 mm			6117	23412	
50 mm			6118	23413	
60 mm			6119	23414	
80 mm			6120	23415	
100 mm			6121	23416	
120 mm			12623		10616
140 mm					12624
160 mm					10617
200 mm	1 support 1 gâche	18032			
250 mm		18033			
300 mm		18034	10615		
400 mm	2 supports 2 gâches	18035			

RUSTIC FITTINGS
FERRURES RUSTIQUES



HANDLE BÉQUILLE



MOD. 101R

12633



MOD. 101K

12631



MOD. 101SP

7974



MOD. 102K

12632



MOD. 102SP

7975

23389

HANDLE BÉQUILLE



MOD. 103D

17581



MOD. 104R

12630

Ø60 mm	17581		
100 x 44 mm		12630	
110 mm		7973	23386

WINDOW HANDLE BÉQUILLE POUR CRÉMONE À ENCASTRER



MOD. 115

11878



MOD. 121

17590



MOD. 122

17591

63 x 28 mm	11878		17591
100 x 22 mm		17590	

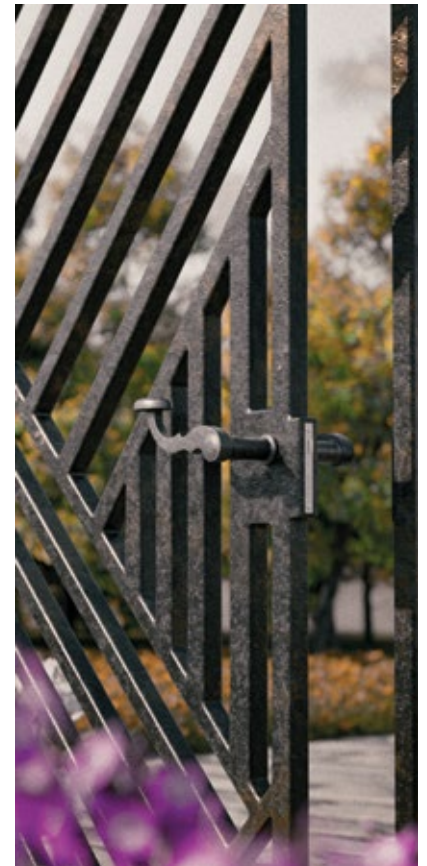



HANDLE MOD. 100P BÉQUILLE MOD. 100P

Sizes Mesures	Cod.	Icons		1	20
		Icon 1	Icon 2		
280 x 44 mm	6100			1	20
	23383			1	10



HANDLE MOD. 100PB BÉQUILLE MOD. 100PB



Sizes Mesures	Cod.	Icons		1	20
		Icon 1	Icon 2		
280 x 44 mm	Keyhole: 47 mm Trou de clé: 47 mm	7815		1	20
		23384		1	10
	Keyhole: 72 mm Trou de clé: 72 mm	7816		1	20
	Keyhole: 70 mm Trou de clé: 70 mm	23550		1	20
	Keyhole: 85 mm Trou de clé: 85 mm	7817		1	20
		23385		1	10
	Keyhole: 90 mm Trou de clé: 90 mm	14933		1	20



HANDLE MOD. 100PW BÉQUILLE MOD. 100PW



Sizes Mesures	Cod.	Icons		1	20
		Icon 1	Icon 2		
280 x 44 mm	Deadbolt handle hole at 47 mm Entreaxe condamnation à 47 mm	17433		1	20
	Deadbolt handle hole at 70 mm Entreaxe condamnation à 70 mm	17434		1	20



HANDLE MOD. 100PG BÉQUILLE MOD. 100PG



Sizes Mesures	Cod.	Icons		1	20
		Icon 1	Icon 2		
280 x 44 mm	Standard keyhole: 72 mm Trou de clé L: 72 mm	7818		1	20
	Standard keyhole: 90 mm Trou de clé L: 90 mm	17432		1	20



HANDLE MOD. 100PEB85 BÉQUILLE MOD. 100PEB85



Sizes Mesures	Cod.	Icons		1	20
		Icon 1	Icon 2		
280 x 45 mm	Left Gauche	17569		1	20
	Right Droite	17570		1	20



HANDLE MOD. 100PEB AT BÉQUILLE MOD. 100PEB AT



Sizes Mesures	Cod.	Icons		1	20
		Icon 1	Icon 2		
280 x 45 mm	Keyhole: 85 mm Trou de clé: 85 mm	20151		1	20
	Keyhole: 70 mm Trou de clé: 70 mm	20152		1	20



HANDLE MOD. 101P BÉQUILLE MOD. 101P

Sizes Mesures	Cod.			
280 x 44 mm	23387	1 ud.	1	10
280 x 45 mm	6101		1	20



HANDLE MOD. 101PB BÉQUILLE MOD. 101PB



Sizes Mesures	Cod.			
280 x 44 mm	Keyhole: 72 mm Trou de clé: 72 mm	17428		1 20
	Keyhole: 85 mm Trou de clé: 85 mm	14173		1 20
	Keyhole: 90 mm Trou de clé: 90 mm	17430		1 20



HANDLE MOD. 101PG BÉQUILLE MOD. 101PG



Sizes Mesures	Cod.			
280 x 44 mm	Standard keyhole: 68 mm Trou de clé L: 68 mm	17435		1 20
	Standard keyhole: 70 mm Trou de clé L: 70 mm	17437		1 20



HANDLE MOD. 101N BÉQUILLE MOD. 101N



NEW

Sizes Mesures	Cod.			
250 x 28 mm	Without spring Sans ressort	25141		1 10



HANDLE MOD. 101NB85 BÉQUILLE MOD. 101NB85



NEW

Sizes Mesures	Cod.			
250 x 28 mm	Without spring Sans ressort	25142		1 10



HANDLE MOD. 102P BÉQUILLE MOD. 102P



Sizes Mesures	Cod.		
280 x 44 mm	6429		1 20

HANDLE MOD. 102PB BÉQUILLE MOD. 102PB



Sizes Mesures	Cod.		
280 x 44 mm	Keyhole: 72 mm Trou de clé: 72 mm	17429	1 20
	Keyhole: 90 mm Trou de clé: 90 mm	17431	1 20
	Keyhole: 85 mm Trou de clé: 85 mm	20483	1 20

HANDLE MOD. 102PG BÉQUILLE MOD. 102PG



Sizes Mesures	Cod.		
280 x 44 mm	Standard keyhole: 68 mm Trou de clé L: 68 mm	17436	1 20

HANDLE MOD. 106P BÉQUILLE MOD. 106P



Sizes Mesures	Cod.		
270 x 36 mm	21676	1 ud.	2 20

HANDLE MOD. 106PB BÉQUILLE MOD. 106PB



Sizes Mesures	Cod.		
270 x 36 mm	Keyhole: 72 mm Trou de clé: 72 mm	21678	1 ud. 2 20
	Keyhole: 90 mm Trou de clé: 90 mm	21679	1 ud. 2 20



HANDLE MOD. 106PG72 BÉQUILLE MOD. 106PG72



Sizes Mesures		Cod.		
270 x 36 mm	Standard keyhole: 72 mm Trou de clé L: 72 mm	21680	1 ud.	2 20



HANDLE MOD. 106PW72 BÉQUILLE MOD. 106PW72



Sizes Mesures		Cod.		
270 x 36 mm	Deadbolt handle hole at 72 mm Entreaxe condamnation à 72 mm	21677	1 ud.	2 20



HANDLE + DOOR FIXED KNOB MOD. 106PB ENSEMBLE PALIÈRE MOD. 106PB



Sizes Mesures		Cod.		
270 x 36 mm	Keyhole: 72 mm Trou de clé: 72 mm	21681	1 ud.	2 20
	Keyhole: 90 mm Trou de clé: 90 mm	21682	1 ud.	2 20



KNOB MOD. 18 BOUTON MOD. 18



Sizes Mesures		Cod.		
280 x 45 x 2 mm	Flat plate Plaque lisse	6133		1 20



KNOB MOD. 19 BOUTON MOD. 19



Sizes Mesures		Cod.		
280 x 45 x 2 mm	Rugged plate Plaque martelée	6433		1 20



PULL HANDLE POIGNÉE DE TIRAGE SUR PLAQUE



MOD. 100



MOD. 101



MOD. 102



MOD. 104



MOD. 105

280 x 45 mm	6102	23390	6280	23391	6430	23392	6491	16184
-------------	------	-------	------	-------	------	-------	------	-------



PULL HANDLE WITH ROSETTE MOD. 103 POIGNÉE DE TIRAGE SUR ROSACE



MOD. 103



MOD. 103D



MOD. 104R

100 mm	20050	23393		
140 mm	6431	23394		20054
190 mm	20051			
240 mm	20052		20053	

HANDLE POIGNÉE



MOD. 1000



MOD. 1001



MOD. 1003



MOD. 1006

80 x 28 mm	6125	23437				
157 x 60 mm			6126	23438		21193 23436
100 x 31 mm					6914	23442 12638



MOD. 1004



MOD. 1005



MOD. 1002

80 x 28 mm			12636	23443		
28 x 80 mm					12637	23443
90 mm	6908	23439				
182 mm	6910	23441				
130 mm	6909	23440				

ESCUTCHEON PLAQUE DE PORTE



MOD. 100



MOD. 101



MOD. 102

92 x 30 mm		6113	23430		
146 x 30 mm	6112	23429		6432	10661



KNOB BOUTON



MOD. 16



MOD. 17

Ø75 mm	6131		
Ø55 - Ø70 mm		6132	23433

DOOR KNOCKER MOD. 1 MARTEAU DE PORTE MOD. 1



Sizes Mesures	Cod.			
110 x 101 mm	6122		1	20

DOOR KNOCKER MOD. 4 MARTEAU DE PORTE MOD. 4



Sizes Mesures	Cod.			
115 mm	8058		1	10

WINDOW LID CLOSER MOD. 12 LOQUET À LEVIER MOD. 12



Sizes Mesures		Cod.			
50 x 25 x 33/15 mm	Offset: 10 mm Rabat: 10 mm	17843		10	100
		23423	1 ud.	5	50
50 x 25 x 38/20 mm	Offset: 15 mm Rabat: 15 mm	17841		10	100
		23424	1 ud.	5	50
50 x 25 x 43/25 mm	Offset: 20 mm Rabat: 20 mm	14351		20	100
		23422	1 ud.	5	50



WINDOW LID CLOSER LOQUET À LEVIER



MOD. 1



MOD. 2



MOD. 3



MOD. 4

60 x 46 mm							12603	23421
75 x 46 mm					Right Droite	7234	23419	
					Left Gauche	7235	23420	
80 x 46 mm	7232	23417	7233	23418				

MOD. 7

MOD. 50

130 mm		15221
150 mm	14191	
200 mm	14192	
250 mm	14193	

KEYHOLE ROSACE DE CLÉ



MOD. 10



MOD. 11



MOD. 12



MOD. 13



MOD. 14G



MOD. 15

60 x 34 mm					12635		17593
60 x 38 mm			12634	23425			17592
67 x 26 x 1,5 mm	6123	6124					

CHAIN DOOR GUARD MOD. 3 ENTREBÂILLEUR MOD. 3



Sizes Mesures	Cod.		
84 mm	17580		10 60
	23644	1 ud.	5 50

DEADBOLT HANDLE ROSACE DE CONDAMNATION



	MOD. 10		MOD. 10P		MOD. 11		MOD. 11P		MOD. 12		MOD. 13	
Ø30 mm	6114	23431	17565									
Ø33 mm					6115		17566					
Ø34 mm											9959	
Ø36 mm									9958	23432		

SHUTTER RETAINER BLOQUE VOLET



	MOD. 1		MOD. 2		MOD. 3		MOD. 6	
100 x 123 mm			18481					
105 x 131 mm	6215	23434						
130 x 60 mm					18482	23435		
157 x 60 mm							21193	23436

HOOK PORTE-MANTEAU



	MOD. 100		MOD. 101		MOD. 102		MOD. 103	
70 x 70 x 85 mm							6493	23428
90 x 90 x 100 mm	6427	23426						
120 x 80 x 90 mm			6428	23427				
210 x 80 x 90 mm					6492			

NAIL CLOU



	MOD. 1			MOD. 2			MOD. 3			MOD. 4			MOD. 5			MOD. 6		
25 mm													13407	17550	29094			
28 mm				6136	10657	29109												
30 mm	6134	10655	29107				13404	17547	29092				13408	17551	29112	17567		
40 mm	6135	10656	29108	6137	10658	29110	13405	17548	29093	13406	17549	29111	19970			17568		
50 mm													19971					

HINGES CHARNIÈRES ET PAUMELLES



HINGE MOD. 550 CHARNIÈRE MOD. 550

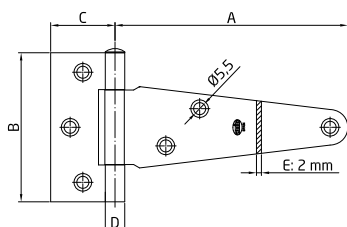

Mod. 550	A	B	C	D
100	109	75	38	11,5
130	138	88	38	11,5
150	155	88	38	11,5
175	188	88	38	11,5
200	207	111	45	12,5
250	262	111	45	12,5
300	312	111	45	12,5
350	350	113	36,5	13
400	400	113	36,5	13
500	500	113	36,5	13

Finish Finition	Sizes Mesures	Cod.			
Black Noir	100 mm	4871		10	100
		23557		1 ud.	5
	130 mm	4872		10	100
		23558		1 ud.	5
	150 mm	4873		10	100
		23559		1 ud.	5
	175 mm	4874		10	80
		23540		1 ud.	5
	200 mm	4875		10	70
		23541		1 ud.	5
	250 mm	4876		10	60
	300 mm	4877		10	40
	350 mm	24596		5	30
	400 mm	24597		5	30
	500 mm	24598		5	30

- Features:**
- > Steel T Hinge.
 - > For flat doors.

- Caractéristiques:**
- > Charnière en T en acier.
 - > Pour porte lisse.

HINGE MOD. 551 CHARNIÈRE MOD. 551

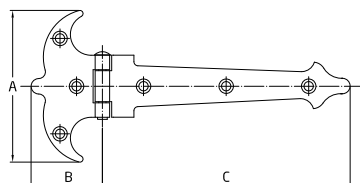

	551 - 90	551 - 120	551 - 150
A (mm)	55	73	100
B (mm)	26,5	34,5	47
C (mm)	90	120	150
Thickness Epaisseur (mm)	1,5	1,5	1,5

Finish Finition	Sizes Mesures	Cod.			
Black Noir	90 mm	6127		10	100
		23395		1 ud.	5
	120 mm	6128		10	100
		23396		1 ud.	5
	150 mm	12625		10	100
		23397		1 ud.	5

- Features:**
- > Hinge made of steel.
 - > Dotted hinge for plain door.

- Caractéristiques:**
- > Charnière en acier.
 - > Charnière en pointillé pour porte lisse.

- Screws included**
Visserie compris

HINGE MOD. 552 CHARNIÈRE MOD. 552

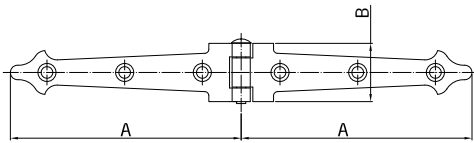

	552 - 180	552 - 240
A (mm)	90	120
B (mm)	22,5	30
Thickness Epaisseur (mm)	1,5	1,5

Finish Finition	Sizes Mesures	Cod.		
Black Noir	180 mm	12626	10	100
	240 mm	6129	10	100
		23398	1 ud.	5

- Features:**
 > Hinge made of steel.
 > Dotted hinge for plain door.

- Caractéristiques:**
 > Charnière en acier.
 > Charnière en pointillé pour porte lisse.

Screws included
Visserie compris

HINGE MOD. 553 CHARNIÈRE MOD. 553

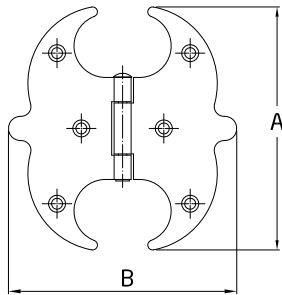

Mod.	553 - 60	553 - 75	553 - 100	553 - 125
A (mm)	60	75	100	125
B (mm)	55	66	91	114
Thickness Epaisseur (mm)	1,5	1,5	1,5	2

Finish Finition	Sizes Mesures	Cod.		
Black Noir	60 mm	6130	20	200
		23399	1 ud.	5
	75 mm	12627	20	200
		23400	1 ud.	5
	100 mm	12628	20	200
		23401	1 ud.	5
	125 mm	12629	20	80

- Features:**
 > Hinge made of steel.
 > Dotted hinge for plain door.

- Caractéristiques:**
 > Charnière en acier.
 > Charnière en pointillé pour porte lisse.

Screws included
Visserie compris

HINGE MOD. 554 CHARNIÈRE MOD. 554

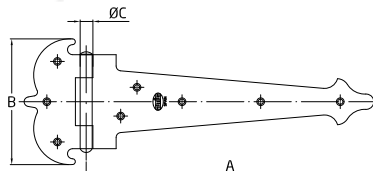

	150	200	250	300	400
A (mm)	150	200	250	300	400
B (mm)	88	111	111	131	131
ØC (mm)	11,5	12,5	12,5	12,5	12,5
Thickness Epaisseur (mm)	2	2	2	2	2

Finish Finition	Sizes Mesures	Cod.		
Black Noir	150 mm	6417	10	100
		23402	1 ud.	5
	200 mm	6418	10	70
		23403	1 ud.	5
	250 mm	6419	10	60
		23404	1 ud.	5
	300 mm	6420	10	40
	400 mm	6421	5	20

- Features:**
 > Reinforced hinge made of steel.
 > Dotted hinge for plain door.

- Caractéristiques:**
 > Charnière renforcée en acier.
 > Charnière en pointillé pour porte lisse.

Screws included
Visserie compris



HINGE PAUMELLE



MOD. 20

MOD. 50

9 x 37 mm	Female Femelle	11847	
	Male Mâle	11848	
11 x 40 mm	Female Femelle	11849	
	Male Mâle	11850	
11 x 78 mm	Female Femelle		6851
	Male Mâle		6852
13 x 44 mm	Female Femelle	6822	
	Male Mâle	6823	
13 x 90 mm	Female Femelle		6858
	Male Mâle		6859

HINGE PAUMELLE



MOD. 2010

MOD. 2012

3" x 3" (76 x 76 x 2 mm)	25096	25099
3,5" x 3,5" (89 x 89 x 2,3 mm)	25097	25100
4" x 4" (101 x 101 x 2,5 mm)	25098	25101



SECURITY HINGE CHARNIÈRE SÉCURITÉ



MOD. 561



MOD. 566



MOD. 567



MOD. 568



MOD. 569



MOD. 571



150 x 82 x 3 mm	3398	14081	2652	4757	10398	18064	24468	24469
-----------------	------	-------	------	------	-------	-------	-------	-------



HINGE PAUMELLE



MOD. 407



MOD. 505



MOD. 507



100 x 58 x 2,3 mm	Right Droite	9843	
	Left Gauche	9844	
110 x 55 x 3 mm	Right Droite		24870
	Left Gauche	24871	23871
140 x 55 x 3 mm	Right Droite		24872
	Left Gauche	24873	23873

PERNIO PAUMELLE



MOD. 403



MOD. 405



MOD. 405C



95 x 52 x 2 mm	Right Droite	544	2562	1272	2574	
	Left Gauche	545	2563	1273	2575	
100 x 56 x 2 mm	Right Droite					17410
	Left Gauche					17411



MOD. 406



MOD. 408



MOD. 408C



95 x 52 x 2 mm	Right Droite	813		1548	2588	
	Left Gauche	814	2585	1549	2589	
100 x 56 x 2 mm	Right Droite					17412
	Left Gauche					17413

HINGE MOD. BG1 PAUMELLE MOD. BG1



4" x 2,5" (100 x 63,5 x 2,5 mm)	24964		
4" x 3" (100 x 75,5 x 2,5 mm)		24965	
4" x 3,5" (100 x 90 x 2,5 mm)			24966

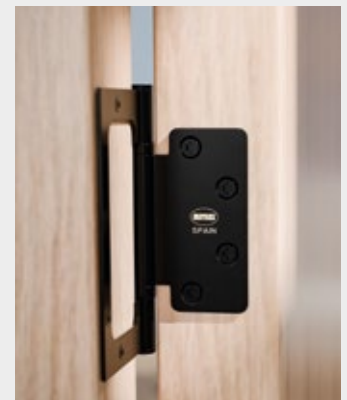

SPRING HINGE MOD. 200 PAUMELLE RESSORT MOD. 200

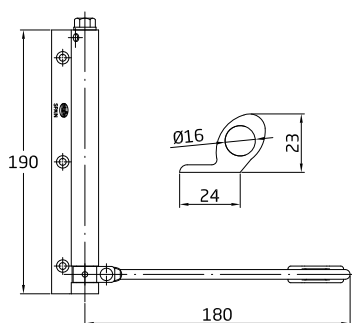

Sizes Mesures	Cod.		
190 x 180 mm	12336		5
	17466		16

Features:

- > Spring hinge with painted steel arm.
- > Flexible elastic steel spring for automatic door closure.
- > Adjustable closing power, Allen key included.
- > Black nylon support.
- > For light doors, 40 kg maximum.

Caractéristiques:

- > Paumelle ressort avec bras en acier peint.
- > Ressort en acier élastique et flexible pour la fermeture automatique des portes.
- > Puissance de fermeture, clé allen inclus.
- > Support en nylon noir.
- > Pour les portes légères, maximum 40 kg.

DOUBLE EFFECT SPRING HINGE MOD. 3035 CHARNIÈRE VA-ET-VIENT DOUBLE ACTION MOD. 3035

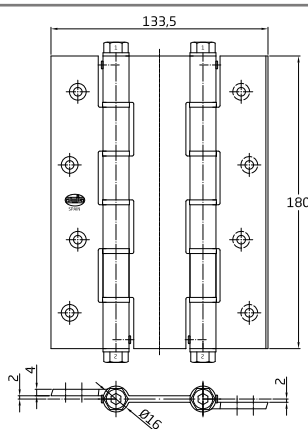
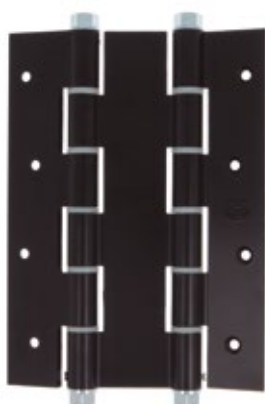

Sizes Mesures	Cod.		
180 x 133 x 4 mm	8368		24

Features:

- > Double-effect spring hinge with square corners.
- > Steel elastic flexible spring for automatic door closing.
- > Adjustable closing power, allen key included.
- > High torsional resistance.

Caractéristiques:

- > Charnière va-et-vient double action avec bord carré.
- > Ressort en acier élastique et flexible pour la fermeture automatique des portes.
- > Puissance de fermeture, clé allen inclus.
- > Grande résistance à la torsion.



DOUBLE EFFECT SPRING HINGE MOD. 3037 CHARNIÈRE VA-ET-VIENT DOUBLE ACTION MOD. 3037

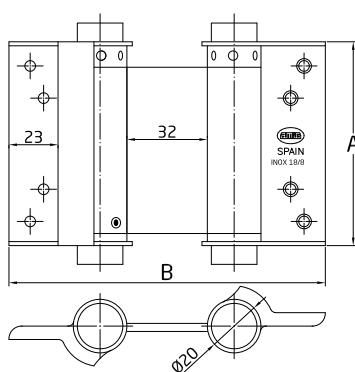

Sizes Mesures	Cod.		
75 x 126 mm	25195		24
100 x 126 mm	25196		24

Features:

- > Double action spring hinge with square edge.
- > Flexible elastic steel spring for automatic door closing.
- > Closing power regulation, includes Allen key.
- > Great resistance to torsion.

Caractéristiques:

- > Charnière à double action avec bord carré.
- > Ressort en acier élastique flexible pour fermeture automatique des portes.
- > Régulation de puissance de fermeture, avec clé Allen.
- > Grande résistance à la torsion.

NEW

SUPPORTS
SUPPORTS



SUPPORT MOD. 353
SUPPORT MOD. 353



Sizes Mesures	Cod.				
80 x 82 x 122 x 162 x 2 mm	15239		10	40	
90 x 42 x 88 x 175 x 2 mm	15240		10	40	
100 x 80 x 141 x 182 x 2 mm	15238		10	40	
100 x 80 x 200 x 182 x 2 mm	17574		4	16	

SUPPORT MOD. 354
SUPPORT MOD. 354



Sizes Mesures	Cod.				
80 x 82 x 122 x 2 mm	15242		10	40	
90 x 42 x 88 x 2 mm	15243		10	40	
100 x 80 x 141 x 2 mm	15241		10	40	
100 x 80 x 200 x 2 mm	17578		4	16	

SUPPORT MOD. 355 SUPPORT MOD. 355



Sizes Mesures		Cod.			
100 x 40 x 63 x 2 mm	Left Gauche	15244		10	40
	Right Droite	15245		10	40
150 x 40 x 63 x 2 mm	Left Gauche	15246		10	40
	Right Droite	15247		10	40

ANGLE MOD. 305
CORNIÈRE MOD. 305



Sizes Mesures		Cod.			
170 x 35 x 2,2 mm	Left Gauche	15273		10	40
	Right Droite	15274		10	40

ADJUSTABLE SUPPORT MOD. 350
PIED DE POTEAU ADAPTABLE MOD. 350



Sizes Mesures		Cod.			
270 x 66 x 200 mm		15236		-	4

ADJUSTABLE SUPPORT MOD. 351
PIED DE POTEAU ADAPTABLE MOD. 351



Sizes Mesures		Cod.			
70 x 16 x 200 mm		15237		-	4



MOD. 1 MOD. 4 MOD. 4 PLUS MOD. 6 MOD. 9 MOD. 10 MOD. 11 MOD. 12

100 x 75 mm (4" x 3")	4365	6034									
120 x 80 mm (5" x 3.2")			3255	21101							
125 x 100 mm (5" x 4")	4366	6035									
150 x 100 mm (6" x 4")			3256	21086	21104						
150 x 125 mm (6" x 5")	4367	6036				3529	5036	8828	8837	8846	
150 x 150mm											
175 x 150 mm (7" x 6")	5667	6037									
200 x 150 mm (8" x 6")	4368	6038	3257	21089	21107	3530	5037		8838		
200 x 150 mm (8" x 6")			3258	21092	21110			8829		8847	
200 x 200 x 20 mm											
225 x 200 mm (9" x 8")	5668	6039									
250 x 200 mm (10" x 8")	4369	6040				3531	5038	9807	8830	8839	8848
300 x 200 mm (12" x 8")			3259	21095	21113						
300 x 225 mm								7383			
300 x 250 mm (12" x 10")	4370	6041				3532	5039				
350 x 200 mm (14" x 8")			3260	21098	21116						
350 x 300 mm (14" x 12")	5669	6042				3533	5040				
400 x 275 mm								7384			
400 x 350 mm (16" x 14")	5670	6043									
450 x 400 mm (18" x 16")	5671	6044									
500 x 325 mm								7385			
600 x 375 mm								8371			



MOD. 2 MOD. 13 MOD. 20 MOD. 21 MOD. 22 MOD. 25

100 x 90 mm (4" x 3,5")	200					
150 x 115 mm (6" x 4,5")	201					
150 x 125 mm (6" x 5")				12353	12362	
150 x 150mm			12347			
200 x 150 mm (8" x 6")	202			12356	12365	
200 x 160 mm						15207
200 x 200 x 20 mm		9957	12350			
250 x 190 mm (10" x 7,5")	203					
250 x 195 mm						15004
250 x 200 mm (10" x 8")				12359	12368	
300 x 240 mm						15001



MOD. 500

MOD. 501

MOD. 502

MOD. 504

MOD. 505

80 x 50 x 2,2 mm	15251				
80 x 100 x 2,2 mm					15255
120 x 50 x 2,2 mm	15248				
120 x 100 x 2,2 mm					15256
160 x 50 x 2,2 mm	15249				
160 x 100 x 2,2 mm					15257
185 x 65 x 2,2 mm		15252			
185 x 90 x 2,2 mm			15253		
200 x 50 x 2,2 mm	15250				
200 x 100 x 2,2 mm					15258
200 x 100 x 2,8 mm				15254	

PLATE MOD. 505 PLAQUE MOD. 505



Sizes

Mesures

Cod.



100 x 20 x 2,5 mm	15259		10	40
206 x 20 x 2,5 mm	15260		10	40
312 x 20 x 2,5 mm	15261		10	40

Features:

- > Perforated flat steel plate.
- > Used for fastening wooden structures.
- > Available in various sizes and finishes.

Caractéristiques:

- > Plaque plate perforée en acier.
- > Utilisée pour la fixation de structures en bois.
- > Disponible en différentes tailles et finitions.



MOD. 300



MOD. 301



MOD. 302



MOD. 303



MOD. 304

40 x 50 x 2,2 mm	15263				
40 x 100 x 2,2 mm					15270
60 x 50 x 2,2 mm	15264				
60 x 100 x 2,2 mm					15271
80 x 50 x 2,2 mm	15265				
80 x 100 x 2,2 mm					15272
90 x 65 x 2,2 mm		15266			
90 x 90 x 2,2 mm			15267		
100 x 50 x 2,2 mm	15262				
100 x 100 x 2,2 mm					15269
103 x 100 x 3 mm				15268	



MOD. 2

MOD. 3

MOD. 4



20 x 16 x 1,5 mm		22506	
30 x 16 x 1,5 mm		22507	
40 x 19 x 2 mm		22508	
50 x 19 x 2 mm		22509	
60 x 19 x 2 mm		22510	
80 x 19 x 2 mm		22511	
100 x 19 x 2 mm		22512	
125 x 125 mm (5" x 5")	4980		
150 x 100 mm (6" x 4")			7401
150 x 125 mm (6" x 5")	4981		
200 x 150 mm (8" x 6")	4982		7402
250 x 200 mm (10" x 8")	4983		7403
300 x 250 mm (12" x 10")	4984		7404
350 x 250 mm (14" x 10")	4985		
400 x 300 mm (16" x 12")	4986		

FIXED HOOK WITH PLATE MOD. 510
PLAQUE AVEC CROCHET FIXE MOD. 510



Sizes Mesures	Cod.				
50 x 50 x 5 mm	24859		10	100	

CLOSED HOOK WITH PLATE MOD. 511
PLAQUE AVEC CROCHET FERMÉ MOD. 511



Sizes Mesures	Cod.				
50 x 50 x 5 mm	24861		10	100	

EYE HOOK WITH RING MOD. 508
ANNEAU SUR PITON À VIS MOD. 508



Sizes Mesures	Cod.				
Ø50 x 139 mm	24857		10	100	

SWING RING WITH PLATE MOD. 507
PLAQUE AVEC ANNEAU MOBILE MOD. 507



Sizes Mesures	Cod.				
70 x 45 mm	24856		10	100	

SWIVEL HOOK WITH PLATE MOD. 509
PLAQUE AVEC CROCHET MOBILE MOD. 509



Sizes Mesures	Cod.				
69 x 45 mm	24858		10	100	

SUPPORTS SUPPORTS

ADJUSTABLE SUPPORT MOD. 7 PIED DE POTEAU ADAPTABLE MOD. 7



Sizes Mesures	Cod.			
300 x 370 x 200 mm	2109		1	10
380 x 450 x 200 mm	3512		1	6

HANDRAIL SUPPORT MOD. 21 SUPPORT DE RAMPE MOD. 21



Cod.			
5542		20	100

HANDRAIL SUPPORT MOD. 24 SUPPORT DE RAMPE MOD. 24



Sizes Mesures	Cod.			
Ø70 mm	6116		10	60
	23444		4	24

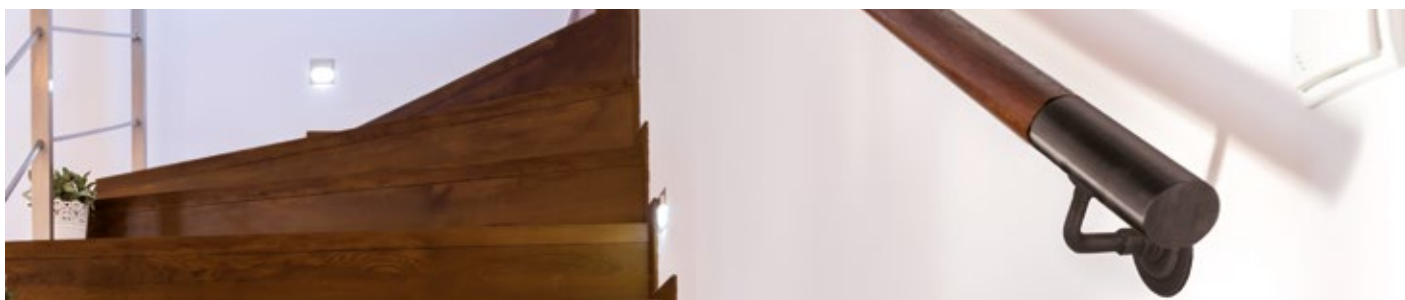

SUPPORT FOR SHELVES MOD. 31 SUPPORT D'ÉTAGÈRES EN VERRE



Sizes Mesures	Cod.			
19 x 38 mm	5800		20	200
23,5 x 50 mm	4945		20	200

SUPPORT FOR SHELVES MOD. 33 SUPPORT D'ÉTAGÈRES EN VERRE



Sizes Mesures	Cod.			
18 x 40 mm	6511		20	200
25 x 50 mm	6506		20	200

SUPPORT FOR SHELVES MOD. 35 SUPPORT D'ÉTAGÈRES EN VERRE



Sizes Mesures	Cod.			
Ø16 x 30 mm	6709		20	200
Ø20 x 30 mm	6704		20	200

SUPPORT FOR SHELVES MOD. 40 SUPPORT D'ÉTAGÈRES EN VERRE



Sizes Mesures	Cod.			
40 x 25 x 45 mm	5769		20	120
	24555		5	30
50 x 30 x 55 mm	4762		20	120
	24550		5	30
75 x 35 x 70 mm	5773		20	120
	24560		5	30
105 x 45 x 100 mm	6437		10	40
	2870		10	50

SUPPORT FOR SHELVES MOD. 44 SUPPORT D'ÉTAGÈRES EN VERRE



Sizes Mesures	Cod.			
60 x 76,5 x 30 mm	10500		10	40

SUPPORT FOR SHELVES MOD. 51 SUPPORT D'ÉTAGÈRES EN VERRE



Sizes Mesures	Cod.			
44 x 42 x 60 mm	6699		20	120
	24565		5	30



SUPPORT SUPPORT



MOD. 3001



MOD. 3002



MOD. 3003

126 x 261 x 30 mm	24978		
211 x 311 x 30 mm		24979	
211 x 261 x 30 mm			24980

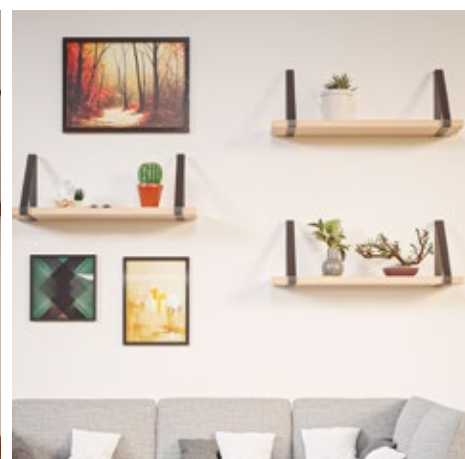
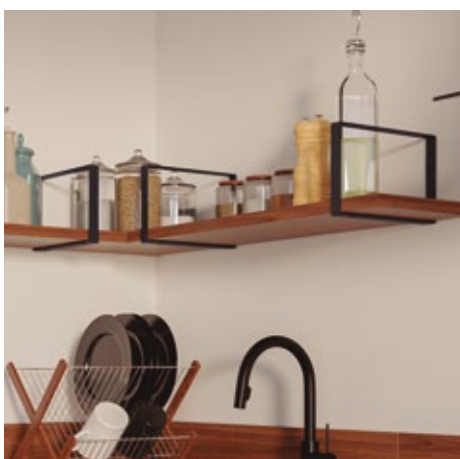

MOD. 3004



MOD. 3005



NEW

MOD. 3006



NEW

MOD. 3007

103 x 211 x 40 mm	24981		
103 x 261 x 40 mm		24982	
180 x 145 x 20 mm			25176
238 x 38 x 20 mm			25181

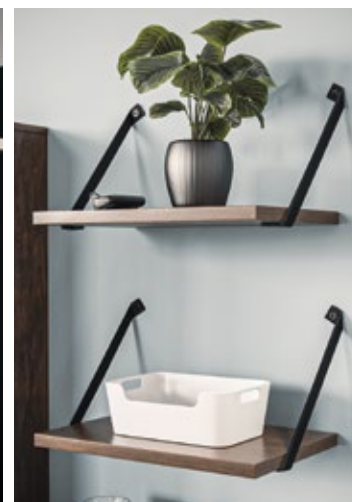
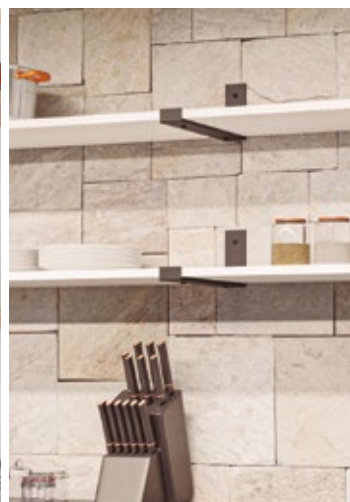

TABLE LEG
PIEDS

TABLE LEG
PIED DE TABLE



MOD. 2400



MOD. 2405



MOD. 2410

712 x 780 x 80 mm	24983	24984	
800 x 300 x 40 mm			24985



TABLE LEG MOD. 21 PIED DE TABLE MOD. 21

ABS



Sizes Mesures	Cod.		
40 x 40 x 100 mm	24739	4 ud.	2 20
40 x 40 x 150 mm	24742	4 ud.	2 20

TABLE LEG PIED DE TABLE



MOD. 1

MOD. 2

MOD. 5

MOD. 6

MOD. 7

MOD. 18

Ø50 x 150 mm			7806			
Ø50 x 710 mm						24064
Ø60 x 710 mm	6535			7809		
Ø60 x 870 mm		6538			7812	

SUPPORT FOR TABLE LEGS MOD. 1-2-6-7 SUPPORT POUR PIEDS DE TABLE MOD. 1-2-6-7



Cod.



21164



1

-

Features:

> Spare support for legs model 1, 2, 6 and 7.

Caractéristiques:

> Support de rechange pour pieds modèle 1, 2, 6 et 7.

TABLE LEG MOD. 3 PIED DE TABLE MOD. 3



Finish Finition	Sizes Mesures	Cod.				
Black Noir	25 x 25 x 100 mm	7410	21715	1 ud.	4	16
	25 x 25 x 150 mm	7413	21718	1 ud.	4	16
	25 x 25 x 200 mm	7416	21721	1 ud.	4	16
	25 x 25 x 250 mm	9853	21724	1 ud.	4	16
	25 x 25 x 300 mm	9854	21727	1 ud.	4	16
	25 x 25 x 350 mm	7419	21730	1 ud.	4	16
	25 x 25 x 400 mm	12191	21733	1 ud.	-	4
	25 x 25 x 500 mm	7422	21736	1 ud.	-	4
	25 x 25 x 600 mm	12194	21739	1 ud.	-	4
	25 x 25 x 700 mm	7425	21742	1 ud.	-	4

TABLE LEG MOD. 4 PIED DE TABLE MOD. 4



Finish Finition	Sizes Mesures	Cod.				
Black Noir	Ø30 x 100 mm	7428	21745	1 ud.	4	16
	Ø30 x 150 mm	7431	21748	1 ud.	4	16
	Ø30 x 200 mm	7434	21751	1 ud.	4	16
	Ø30 x 250 mm	9855	21754	1 ud.	4	16
	Ø30 x 300 mm	9856	21757	1 ud.	4	16
	Ø30 x 350 mm	7437	21760	1 ud.	4	16
	Ø30 x 400 mm	12197	21763	1 ud.	-	4
	Ø30 x 500 mm	7440	21766	1 ud.	-	4
	Ø30 x 600 mm	12200	21769	1 ud.	-	4
	Ø30 x 700 mm	7443	21772	1 ud.	-	4

FURNITURE FITTINGS QUINCAILLERIE DU MEUBLE



HANDLE POIGNÉE



MOD. 5

MOD. 55

MOD. 70

MOD. 77

MOD. 110

MOD. 118

MOD. 900

MOD. 15



NEW

73 mm							10403	
85 mm	10518						10404	
96 mm		3989	4088	4037	4053			
100 mm								25231
105 mm	10519							
125 mm	10520							25232
128 mm				4041	4057			
140 mm		24614						
145 mm	10521							
165 mm	10522							
185 mm	10523							



HINGE PAUMELLE



MOD. 541



MOD. 555



MOD. 557



60 x 41 x 1,2 mm	Right Droite	5162	22109		
	Left Gauche	5163	22110		
70 x 43 x 1,2 mm	Right Droite	5164	22115		
	Left Gauche	5165	22116		
95 mm				18909	22131
100 mm					18896 22120

BALL KNOB BOUTON ROND



MOD. 60



MOD. 61



MOD. 62



Ø25 mm	3964		
Ø30 mm	3969	3979	
Ø35 mm	3974	3984	3959



DRAWER SLIDES COULISSES DE TIROIRS À GALET



	Sizes Mesures	Cod.		
MOD. 10	250 x 37 mm	5826		10
MOD. 12	300 x 37 mm	5827		10
MOD. 14	350 x 37 mm	5828		10
MOD. 16	400 x 37 mm	5829		10
MOD. 18	450 x 37 mm	5830		20
MOD. 20	500 x 37 mm	5831		10
MOD. 22	550 x 37 mm	5832		10
MOD. 24	600 x 37 mm	5833		10

PROFILES PROFILS

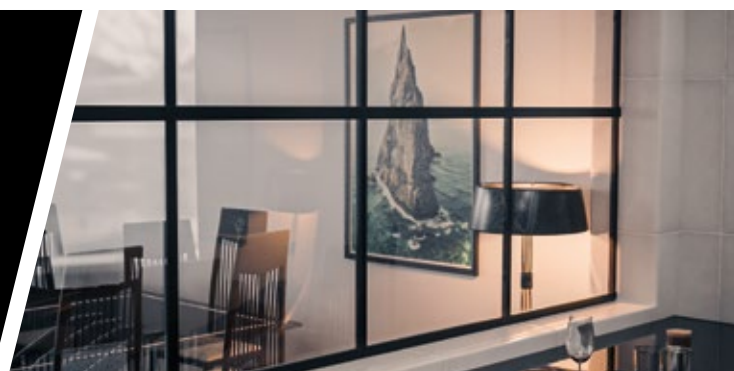

Sizes Mesures

Cod.











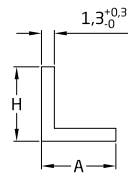























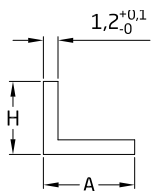









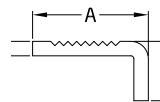

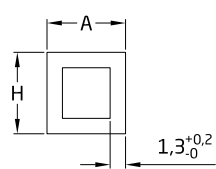



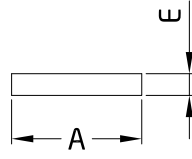







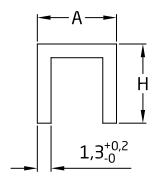

		Sizes Mesures	Cod.			
PVC profile U Profil U en PVC		19 x 19 mm	1 m	21250		10
			2,5 m			
Equal PVC angle Cornière égale en PVC		15 x 15 mm	1 m	20850		10
			2,5 m	20852		10
		20 x 20 mm	1 m	20856		10
			2,5 m	20863		10
		25 x 25 mm	1 m	20868		10
			2,5 m	20870		10

Sizes
Mesures

Cod.

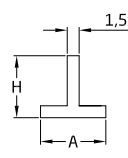

Equal aluminium angle Cornière égale en aluminium		Unequal aluminium angle Cornière inégale en aluminium		Aluminium stairs angle Nez de marche en aluminium		Aluminium square tube Tube carré en aluminium		Aluminium flat profile Plat en aluminium		Aluminium U profile Profil U en aluminium		Aluminium T profile Profil T en aluminium	
   	10 x 10 mm	1 m	25000		-	10	20 x 20 mm	1 m	25002		-	10	
		2,5 m	25005		-	10		2,5 m	25007		-	10	
	15 x 15 mm	1 m	25001		-	10	25 x 25 mm	1 m	25003		-	10	
		2,5 m	25006		-	10		2,5 m	25008		-	10	
	20 x 20 mm	1 m	25002		-	10	30 x 30 mm	1 m	25004		-	10	
		2,5 m	25007		-	10		2,5 m	25009		-	10	
	25 x 25 mm	1 m	25003		-	10	40 x 40 mm	1 m	25078		-	10	
		2,5 m	25008		-	10		2,5 m	25080		-	10	
	30 x 30 mm	1 m	25004		-	10	50 x 50 mm	1 m	25079		-	10	
		2,5 m	25009		-	10		2,5 m	25081		-	10	
	 	20 x 10 mm	1 m	25010		-	10	30 x 15 mm	1 m	25011		-	10
			2,5 m	25013		-	10		2,5 m	25014		-	10
30 x 20 mm		1 m	25012		-	10	30 x 20 mm	1 m	25012		-	10	
		2,5 m	25015		-	10		2,5 m	25015		-	10	
 	40 x 15 mm	1 m	25016		-	10							
 	20 x 20 mm	1 m	25031		-	10							
		2,5 m	25032		-	10							
 	15 x 3 mm	1 m	25025		-	10							
		2,5 m	25028		-	10							
	20 x 3 mm	1 m	25026		-	10							
		2,5 m	25029		-	10							
	30 x 3 mm	1 m	25027		-	10							
		2,5 m	25030		-	10							
 	10 x 10 mm	1 m	25019		-	10							
		2,5 m	25022		-	10							
	15 x 15 mm	1 m	25020		-	10							
		2,5 m	25023		-	10							
	20 x 20 mm	1 m	25021		-	10							
		2,5 m	25024		-	10							
 	20 x 20 mm	1 m	25017		-	10							
		2,5 m	25018		-	10							

HARDWARE-HOME QUINCAILLERIE-MAISON



MAILBOX WITH BACK OPENING MOD. 5 BOÎTE AUX LETTRES MOD. 5



Sizes Mesures	Cod.		
400 x 250 x 100 mm	12370	1	6
400 x 360 x 100 mm	12372	1	6

Features:

- > Steel mailbox with back opening.
- > For indoors.
- > Includes screws for installation.

Caractéristiques:

- > Boîte aux lettres en acier avec ouverture à l'arrière.
- > Pour l'intérieur.
- > Inclut les vis pour l'installation.

NEWSPAPER BASKET MOD. 77 BOÎTE PUBLICITÉ MOD. 77



Sizes Mesures	Cod.		
220 x 360 x 190 mm	13411	1	6
320 x 360 x 190 mm	13414	1	6

Features:

- > Advertising basket.
- > For walls, fences, or exterior doors.
- > With front grille.

Caractéristiques:

- > Panier publicitaire.
- > Pour murs, clôtures ou portes extérieures.
- > Avec une grille avant.

LETTER SLOT ENTRÉE DE BOÎTE AUX LETTRES



Sizes Mesures	Cod.		
254 x 78 mm	17588	1 ud.	4 16
342 x 73 mm	17589	1 ud.	4 16

Features:

- > Steel letter slot.
- > Suitable for letters and small parcels.

Caractéristiques:

- > Boîte aux lettres en acier.
- > Convient pour lettres et de petits paquets.

LATERAL DRYING HOOK MOD. 3 ÉTENDOIR LATÉRAL MOD. 3



Sizes Mesures	Cod.		
450 mm	25184	1	4

Features:

- > Steel lateral drying hook.
- > 6 stainless steel clothesline pulleys.
- > Fixation accessories included.
- > For 3 lines.

Caractéristiques:

- > Séchoir à linge en acier latéral.
- > 6 poulies en acier inoxydable.
- > Accessoires de fixation inclus.
- > Pour 3 cordes.

LETTERS LETTRES // NUMBERS CHIFFRES



Sizes Mesures	Cod.						
4" - 100 mm	A	17556	0	9857	1 ud.	5	50
	B	17557	1	9858	1 ud.	5	50
	C	17558	2	9859	1 ud.	5	50
	D	17559	3	9860	1 ud.	5	50
	E	17560	4	9861	1 ud.	5	50
	F	17561	5	9862	1 ud.	5	50
	G	17562	6	9863	1 ud.	5	50
	H	17563	7	9864	1 ud.	5	50
	I	17564	8	9865	1 ud.	5	50
			9	9866	1 ud.	5	50

Features:

- > For interior or exterior use.
- > Plugs and lag screws included.

Caractéristiques:

- > Pour l'intérieur ou l'extérieur.
- > Chevilles et tire-fond inclus.



RACK DISPLAYS PRÉSENTOIRS

Check out our wide range of rack displays and configurations.

Consultez notre large gamme de présentoirs et de configurations.



RACK DISPLAYS BY FAMILY PRODUCT PRÉSENTOIRS PAR FAMILLE DE PRODUITS

We advise you to adapt the configuration of the rack/shelving to your needs.

Nous vous conseillons d'adapter la configuration du présentoir/étagère selon vos besoins.

Consult the available options with your AMIG advisor.

Consultez les options disponibles avec votre conseiller AMIG



IMPLEMENTATION PROFILES

IMPLANTATION PROFILS

Profile implementation

This implementation of black profiles allows you to offer your clients a range that assists in any renovation or construction, providing solutions with a current trend.

Implantation de profils

Cette implantation de profils noirs permet d'offrir à vos clients une gamme qui aide dans toute rénovation ou construction, proposant des solutions avec une tendance actuelle.



IMPLEMENTATION

BLACK KNOBS AND SUPPORTS NO. 1

IMPLANTATION

PALETTES ET SUPPORTS NOIRS N° 1

Black Knobs and Supports No. 1

This implementation features a wide selection of black knobs and angles in various models and sizes.

The trend for black solutions is on the rise, allowing your clients to choose from several models and sizes in this finish, providing solutions for a variety of decorative styles.

Palettes et supports noirs n° 1

Cette implantation présente une large sélection de palettes et d'angles noirs dans une variété de modèles et de tailles.

La tendance des solutions noires est en plein essor, permettant à vos clients de choisir parmi plusieurs modèles et tailles dans cette finition, offrant ainsi des solutions pour une variété de styles décoratifs.



IMPLEMENTATION

BLACK DOOR HARDWARE NO. 1

IMPLANTATION

QUINCAILLERIE NOIRE PORTE N° 1

Implementation of Black Door Hardware No. 1

This solution is perfect if you want to offer your clients a range of door hardware in a black finish, adding a trendy touch to your lineup.

It includes all the door accessories in this finish and display presentation, featuring a selection of handles, seals, door knobs, stops, and more.

Implantation de la quincaillerie noire porte n° 1

Cette solution est parfaite si vous souhaitez offrir à vos clients une gamme de quincaillerie pour portes en finition noire, apportant une touche tendance à votre assortiment.

Elle est composée de tous les accessoires de porte dans cette finition et présentation d'affichage, avec une sélection de poignées, joints, boutons de porte, butées, etc.

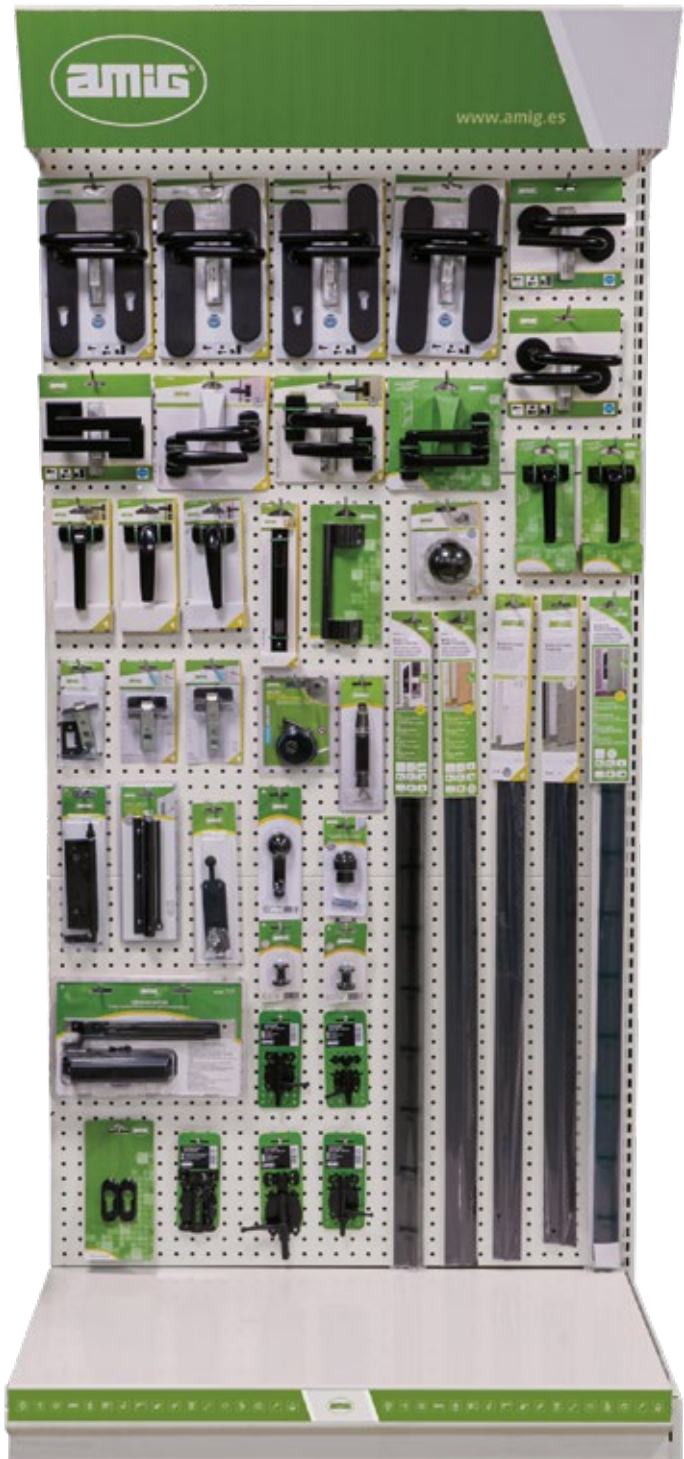



Amilibia y De la Iglesia, S.A.

📍 Pl. Zubieta s/n. 48340 Amorebieta (Bizkaia) SPAIN

☎ +34 946 300 300

✉ amig@amig.es

www.amig.es